

COVER GRAPHIC PLACEHOLDER

ROTEL

Owner's Manual

RDV-1040

DVD Player

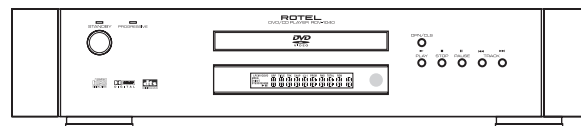



APPLICABLE FOR USA, CANADA OR WHERE APPROVED FOR THE USAGE

CAUTION: TO PREVENT ELECTRIC SHOCK, MATCH WIDE BLADE OF PLUG TO WIDE SLOT. INSERT FULLY.

ATTENTION: POUR EVITER LES CHOCS ELECTRIQUES, INTRODUIRE LA LAME LA PLUS LARGE DE LA FICHE DANS LA BORNE CORRESPONDANTE DE LA PRISE ET POUSSER JUSQU'AU FOND.

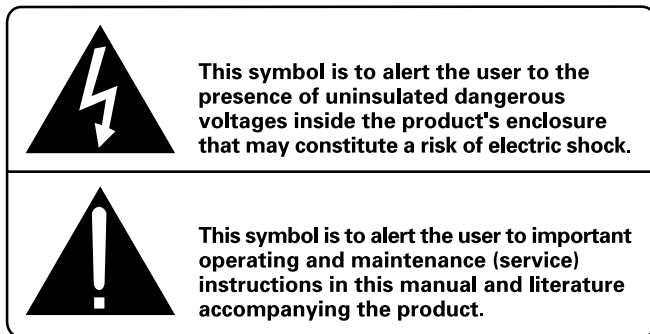

This equipment has been tested and found to comply with the limits for a Class B digital device, pursuant to part 15 of the FCC Rules. These limits are designed to provide reasonable protection against harmful interference in a residential installation.

This equipment generates, uses and can radiate radio frequency energy and, if not installed and used in accordance with the instructions, may cause harmful interference to radio communications. However, there is no guarantee that interference will not occur in a particular installation. If this equipment does cause harmful interference to radio or television reception, which can be determined by turning the equipment off and on, the user is encouraged to try to correct the interference by one or more of the following measures:

Reorient or relocate the receiving antenna.

Increase the separation between the equipment and receiver.

Connect the equipment into an outlet on a circuit different from that to which the receiver is connected.

Consult the dealer or an experienced radio/TV technician for help.

IMPORTANT FOR LASER PRODUCTS

1. CLASS 1 LASER PRODUCT

2. DANGER: Visible laser radiation when open and interlock failed or bypassed. Avoid direct exposure to beam.

3. CAUTION: Do not open the top cover. There are no user serviceable parts inside the player; leave all servicing to qualified service personnel.

WARNING!

To reduce the risk of electrical shock, fires, etc.:

1. Do not remove screws, covers or cabinet.
2. Do not expose the unit to rain or moisture.
3. Do not touch the power cord or plug with wet hands.

Important Safety Instructions

WARNING: There are no user serviceable parts inside. Refer all servicing to qualified service personnel.

WARNING: To reduce the risk of fire or electric shock, do not expose the unit to moisture or water. Do not allow foreign objects to get into the enclosure. If the unit is exposed to moisture, or a foreign object gets into the enclosure, immediately disconnect the power cord from the wall. Take the unit to a qualified service person for inspection and necessary repairs.

Read all the instructions before connecting or operating the component. Keep this manual so you can refer to these safety instructions.

Heed all warnings and safety information in these instructions and on the product itself. Follow all operating instructions.

Clean the enclosure only with a dry cloth or a vacuum cleaner. Do not use benzene, thinner or other organic solvents and disinfectants. These may cause deformation or discoloring.

You must allow 15 cm (6 inches) of clearance behind, 3 cm (1.25 inches) to the sides and 5 cm (2 inches) above the unit. Do not place the unit on a bed, sofa, rug, or similar surface that could block the ventilation slots. If the component is placed in a bookcase or cabinet, there must be ventilation of the cabinet to allow proper cooling.

Keep the component away from radiators, heat registers, stoves, or any other appliance that produces heat.

The unit must be connected to a power supply only of the type and voltage specified on the rear panel of the unit.

Connect the component to the power outlet only with the supplied power supply cable or an exact equivalent. Do not modify the supplied cable in any way. Do not attempt to defeat grounding and/or polarization provisions. Do not use extension cords.

Do not route the power cord where it will be crushed, pinched, bent at severe angles, exposed to heat, or damaged in any way. Pay particular attention to the power cord at the plug and where it exits the back of the unit.

The power cord should be unplugged from the wall outlet if the unit is to be left unused for a long period of time.

Immediately stop using the component and have it inspected and/or serviced by a qualified service agency if:

- The power supply cord or plug has been damaged.
- Objects have fallen or liquid has been spilled into the unit.
- The unit has been exposed to rain.
- The unit shows signs of improper operation
- The unit has been dropped or damaged in any way

Place the unit on a fixed, level surface strong enough to support its weight. Do not place it on a moveable cart that could tip over.



Figure 1: RR-DV96 Remote Control

1 TV/DVD switch

Switches the RDV-1040 between TV control mode and the DVD player control mode.

2 OPEN/CLOSE button

Opens and closes the disc tray.

3 Repeat button

Switches the RDV-1040 among "no repeat" mode, "repeat 1" mode and to "repeat all" mode.

4 Numeric buttons

In DVD/CD mode use these to select a title or track number, to enter a time for the Time search. In TV mode they are used to select a TV channel.

5 SUBTITLE button

Used to activate the on-screen subtitle selection display and to turn the subtitle on or off (for DVD VIDEO).

6 ANGLE button

Changes camera angles during playback of a DVD VIDEO disc containing multiple camera angles.

7 TITLE/GROUP button

Displays the title menu of a DVD Video disc on the TV screen. Group function not used.

8 I◀◀/PREVIOUS button

Skips back a chapter, title or track. Also used for the page selection of a menu screen (for DVD VIDEO/Video CD). Holding down this button during playback rapidly scans to earlier scenes.

9 ■ (STOP)/CLEAR button

Stops playback. Also used to erase all the programmed tracks for the program play.

10 ◀◀/SLOW - button

During playback lets you reverse disc play at 1.5 to 60 times normal speed. When disc play is paused press to reverse disc play at 1/2 to 1/32 normal speed.

11 TOP MENU button

Press to display a menu to select specific scenes on a disc.

12 VOLUME -/CURSOR ◀ Button

When in TV mode press to reduce volume. When in DVD mode press to select an item from a menu or on-screen display, or to change the setting of an item in the on-screen display.

13 CHANNEL -/CURSOR ▼ Button

When in TV mode press to go to a lower channel. When in DVD mode press to select an item from a menu or on-screen display, or to change the setting of an item in the on-screen display.

14 CHOICE button

Displays the DVD set-up menu. Is also used when selecting parental lock settings

15 Infrared signal output window

Point this toward the remote sensor on the front panel when pressing buttons.

16 DVD POWER button

Press to turn the RDV-1040 or your TV on or off (standby).

18 RETURN button

Returns to the previous menu (for SVCD/Video CD).

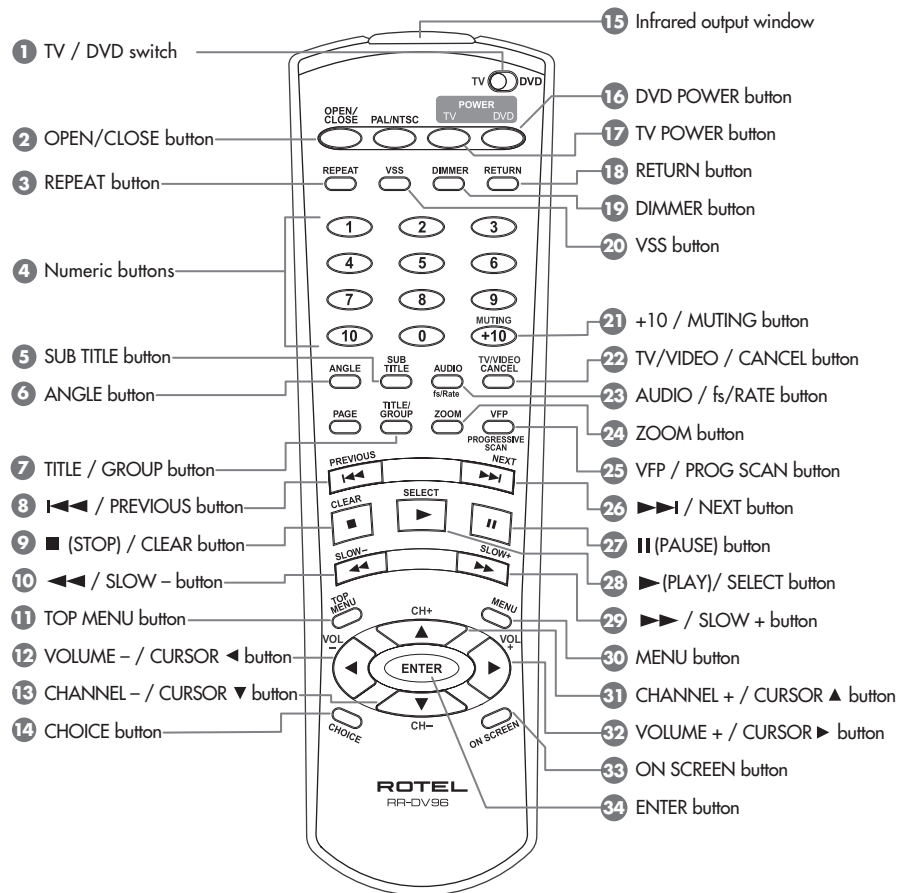

19 DIMMER button

Adjusts the brightness or turns off the display.

20 VSS button

Turn on/off the simulated Virtual Surround Sound system.

21 +10/MUTING button

Used when selecting or programming numbered tracks or scenes above 10. During disc play press to mute sound.

22 TV/VIDEO/CANCEL button

Used to switch inputs when controlling the TV. Used to remove selected items when setting up programmed track play. Also used when setting up the RR-DV96 to control the TV.

23 AUDIO/fs/RATE button

Selects various audio options during disc play. fs/RATE function is not used.

24 ZOOM button

When viewing video discs allows the image on the screen to be enlarged from 1.8 to 64 times normal size.

25 VFP/PROG SCAN button

The VFP function is used to set video play properties. Progressive Scan function is used to select interlaced or progressive scan output when the Video Signal Selector switch 20 is set to Remote. See the Audio/Video Connections section.

26 ▶▶/NEXT button

Skips forward a chapter, title or track. Holding down this button during playback advances playback rapidly.

27 II (PAUSE) button

Pauses playback.

28 ▶ (PLAY)/SELECT button

Starts playback. SELECT function is not used.

29 ▶▶/SLOW button

During playback lets you advance disc play at 1.5 to 60 times normal speed. When disc play is paused press to advance disc play at 1/2 to 1/32 normal speed.

30 MENU button

Displays various menus that let you select items from the disc.

31 CHANNEL +/CURSOR ▲ Button

When in TV mode press to go to a higher channel. When in DVD mode press to select an item from a menu or on-screen display, or to change the setting of an item in the on-screen display.

32 VOLUME +/CURSOR ▶ Button

When in TV mode press to increase volume. When in DVD mode press to select an item from a menu or on-screen display, or to change the setting of an item in the on-screen display.

33 ON SCREEN Button

Displays various menus on the screen that let you select control and programming functions.

34 ENTER button

Press to accept various selections such as channels selected with the numeric buttons or in some programming steps.

Figure 2: Front Panel Controls

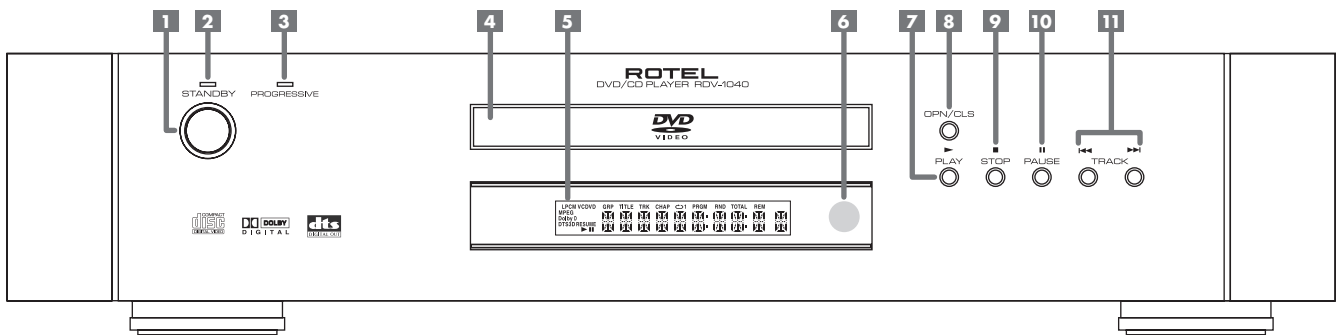
**1 STANDBY button**

Turns the unit on or off (standby).

2 STANDBY indicator

Lights when the power cord is connected and the unit is on standby. When the unit is turned on, the STANDBY indicator goes off.

3 PROGRESSIVE indicator

Lights when the Progressive Scan feature has been activated for use with HDTV monitors. The indicator lights in RED for Video source and GREEN for Film source.

4 Disc tray

Used to load discs.

5 Display Window

Shows various indicators and information about the operation of the RDV-1040

6 Remote sensor

Receives the signal from the remote control unit.

7 ► (PLAY) button

Starts playback. Also, used as a SELECT button for PBC of Video CDs.

8 OPN/CLS (OPEN/CLOSE) button

Opens and closes the disc tray.

9 ■ (STOP) button

Stops playback.

Also used to erase all programmed tracks for the program play.

10 || (PAUSE) button

Pauses playback.

11 ◀▶ (SKIP) buttons

Used to skip a chapter, title or track. Also used for the page selection of a menu screen (for DVD Video/Video CD).

Holding down ◀▶ during playback reverses or advances playback rapidly.

Figure 3: Display Window

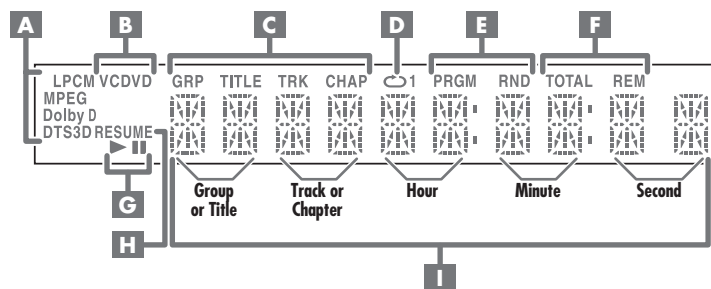
A Audio Format indicators**B Disc indicator****C Group/Title/Track/Chapter indicators****D Repeat Mode indicator****E Program/Random indicators****F Total Time/Remaining Time indicators****G ► (Play)/|| (Pause) indicators****H Resume indicator****I Multi-information window**

Contents

Important Safety Instructions	2
Contents	5
About Rotel	5
About This Manual	5
About the RDV-1040	5
Precautions	6
Audio/Video Connections	6
Connecting the Power Cord	9
RR-DV96 Remote Control	9
Playable Discs	10
Disc Care and Handling	10
Getting Started	11
Initial Setup	11
Basic Disc Play	12
Resuming Playback	12
Various Speed Playback	13
Locating the Beginning of a Scene or Song	13
Screen Saver Function	14
Advanced Operations	14
Playing From a Specific Position	14
Changing Playback Order	15
Repeat Playback	16
Changing the Language, Sound and Scene Angle	16
Special Picture/Sound Effects	17
Menu Bar Functions	18
Basic MP3 Operations	19
About JPEG Discs	20
Basic JPEG Operations	21
Selecting Preferences	22
Limiting Playback by Children	24
Troubleshooting	25
Glossary	26
Specifications	27
Appendix A: Country Code List for Parental Lock	28
Appendix B: Table of Languages and Their Abbreviations	29
Appendix C: Digital Signal Output Chart	29

About Rotel

A family whose passionate interest in music led them to manufacture high fidelity components of uncompromising quality founded Rotel over 40 years ago. Through the years that passion has remained undiminished and the family goal of providing exceptional value for audiophiles and music lovers regardless of their budget, is shared by all Rotel employees.

The engineers work as a close team, listening to, and fine tuning each new product until it reaches their exacting musical standards. They are free to choose components from around the world in order to make that product the best they can. You are likely to find capacitors from the United Kingdom and Germany, semi conductors from Japan or the United States, while toroidal power transformers are manufactured in Rotel's own factory.

Rotel's reputation for excellence has been earned through hundreds of good reviews and awards from the most respected reviewers in the industry, who listen to music every day. Their comments keep the company true to its goal - the pursuit of equipment that is musical, reliable and affordable.

All of us at Rotel, thank you for buying this product and hope it will bring you many hours of enjoyment.

About This Manual

Throughout this manual the controls and components of the RDV-1040 are identified with numbers and letters in dark gray circles and squares.

Numbers in circles such as  identify items on the RR-DV96 remote control. (To help you remember this think of "round equals remote".)

Numbers in squares such as  identify items on the front and rear panel of the unit.

Letters in squares such as  identify items in the front panel display window.

In the operation section of the manual some function descriptions apply only to certain kinds of discs. The types of discs to which the information applies are indicated with symbols such as .

About the RDV-1040

Thank you for purchasing the Rotel RDV-1040. It will provide years of enjoyment when used in a high-quality home theater system.

The RDV-1040 is one of the most flexible components you can add to your audio/video system. In addition to DVD Video discs, the RDV-1040 can play Video and audio CD discs recorded in a variety of formats. It provides a full range of operating features and control functions.

Angle function*

You can select a desired angle from multiple camera angles recorded on the DVD disc.

Zoom function

You can view scenes close-up.

Parental lock*

You can restrict the playback of DVD discs with scenes which you do not want your child to see, such as adult or violent films.

Video Fine Processor (VFP) controls

You can adjust many video image characteristics to suit the type of program being played or personal preferences.

High quality digital sound

You can enjoy high quality sound with Dolby Digital or Linear-PCM, MPEG Multichannel or DTS (Digital Theater Systems).

Surround function*

The unit is compatible with Dolby Digital surround and DTS surround.

3D Phonic (VSS) function

You can enjoy surround sound with your 2-channel system.

Multi-language subtitles and sound*

You can select a subtitle or sound language from those recorded on the DVD disc.

Multi-disc playback

The RDV-1040 can play Audio CDs and Video CDs as well DVD Video discs.

On-screen display

User-friendly on-screen displays allow you to operate the unit easily.

* Functions only with DVD discs.

Precautions

Please read this manual carefully, particularly the Caution information on page 2. In addition to basic installation and operating instructions this manual provides valuable information on various system configurations as well as general information that will help you get the most from your system. Please contact your authorized Rotel dealer for answers to any questions you might have. In addition, all of us at Rotel welcome your questions and comments.

Save the RDV-1040 shipping carton and all enclosed packing material for future use. Shipping or moving the RDV-1040 in anything other than the original packing material may result in severe damage.

Be sure to keep the original sales receipt. It is your best record of the date of purchase, which you will need in the event warranty service is ever required.

Placement

Place the RDV-1040 on a surface that is level, dry and neither too hot nor too cold (between 5°C and 35°C, 41°F and 95°F). Do not place the unit where it will be exposed to direct sunlight. Avoid locations that are dusty. Do not place the unit too close to the television set. Do not place the RDV-1040 where it will be exposed to vibrations, such as near a subwoofer. To ensure proper ventilation observe the minimum clearance specifications listed in the safety information on page 2.

Audio/Video Connections

NOTE: Do not plug in the power cable until all audio/video signal connections are complete. Do not change any audio/video cable connections until the RDV-1040 has been unplugged from the power outlet.

Carefully read the instructions supplied with the components you are going to connect to the RDV-1040 to be sure they are compatible. If you have questions, contact your authorized Rotel dealer.

NOTE: Connect VIDEO OUT 16 of the unit directly to the video input of your TV. Connecting VIDEO OUT to a TV via a VCR may result in unacceptable video quality because many discs are copy-protected.

19 NTSC/PAL Output Signal Selector Switch

Set to NTSC for television sets in North America. Set to PAL for television sets in Europe.

20 Remote/480p/480i Output Signal Selector Switch

Set this switch to 480i (Interlace Scan mode) for normal TV. Set it to 480p (Progressive Scan mode) for HDTV. The Progressive Scan mode produces a picture with less flicker than the Interlaced Scan mode. If you want select the scanning mode with the RR-DV96 remote control, set the switch to REMOTE.

NOTES: The setting of this switch should be changed only when the RDV-1040 is turned off.

The Progressive mode can be used only when the Output Signal switch is set to NTSC and the Component Output connections are used.

Some progressive scan TV sets and HDTV sets are not fully compatible with the RDV-1040.

To change the Interlace/Progressive scanning setting with the RR-DV96 the RDV-1040 must be turned on. Then press and hold PROG/VFP button 25 for a few seconds. The Progressive setting is used only with NTSC (North American) TV sets connected via the Component Video outputs.

Figure 4: Rear Panel Connections

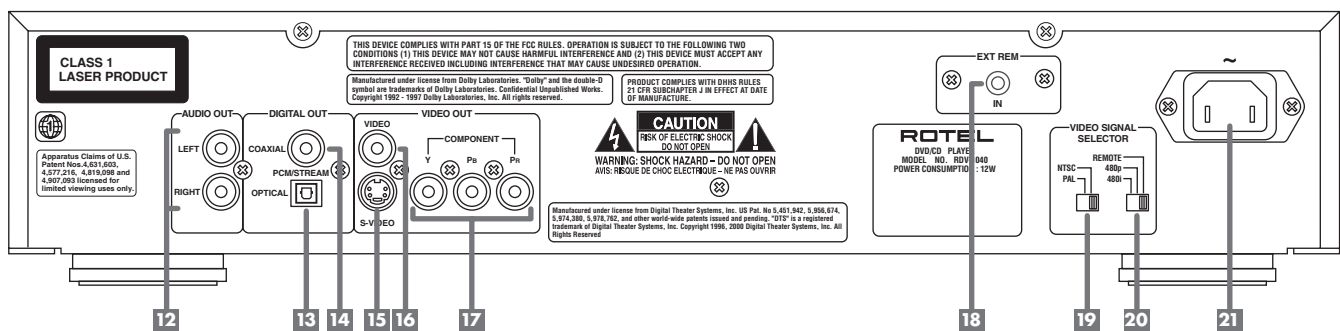

12 Audio ANALOG OUTPUT jacks

Left and right channel analog audio outputs.

13 DIGITAL OUT – OPTICAL jack

14 DIGITAL OUT – COAXIAL jack

Provide digital output signals. The output you use (Optical or Coaxial) must be set in the "Preference" on-screen menu.

15 S VIDEO OUTPUT jack

Outputs an S-video signal.

16 COMPOSITE VIDEO OUTPUT jack

Outputs a composite video signal.

17 COMPONENT VIDEO OUTPUT jacks

Outputs component video signals.

18 External Remote Input ("Ext Rem In")

This feature is useful when the unit is installed in a cabinet and the front panel IR sensor is blocked.

19 NTSC/PAL Output Selector

Selects NTSC and PAL output signals.

20 Video Signal Selector

Changes the output signal between Interlaced and Progressive scanning or allows the setting to be changed with the RR-DV96 remote.

21 AC power cord receptacle

For the power cord connected to the wall outlet.

Composite Input TV Connection

Connect the COMPOSITE VIDEO 16 output to the composite video input of your TV. Connect the ANALOG AUDIO 12 outputs to the audio inputs of your TV. A cable for these connections is supplied.

If your TV has a single monaural audio input instead of a pair of stereo inputs, you need to use a "Y" cable adapter to connect the two output channels of the RDV-1040 to the single input.

You can improve the sound quality of the system by connecting the audio outputs to a separate hi-fi audio system. (See the following section.)

If your TV has an S-video input, you should connect it with the S-VIDEO 15 output of RDV-1040 using an S-video cable in addition to the standard video cables. This will produce better picture quality.

NOTE: The Composite Video outputs should not be connected when the Component and/or S-Video outputs are connected.

Component Input TV Connection

If your TV has component video signal input jacks you will get better video performance by using the COMPONENT VIDEO 17 output jacks of the RDV-1040. The required cable is not provided. Be sure to connect the "Y" output to the "Y" input, "Pb" output to the "Pb" input, and the "Pr" output to the "Pr" input.

If your TV has an S-video input, you should connect it with the S-VIDEO 15 output of RDV-1040 using an S-video cable in addition to the standard video cables. This will produce better picture quality.

NOTE: If you do not connect the S-Video cable between the two components some functions of your TV may not work.

You can improve the sound quality of the system by connecting the audio outputs to a separate hi-fi audio system. (See the following section.)

NOTE: The component signal inputs on some TV's have BNC type connectors. (BNC connectors are coaxial connectors that have keyed locking collars.) In such instances adapters or a special cable may be needed.

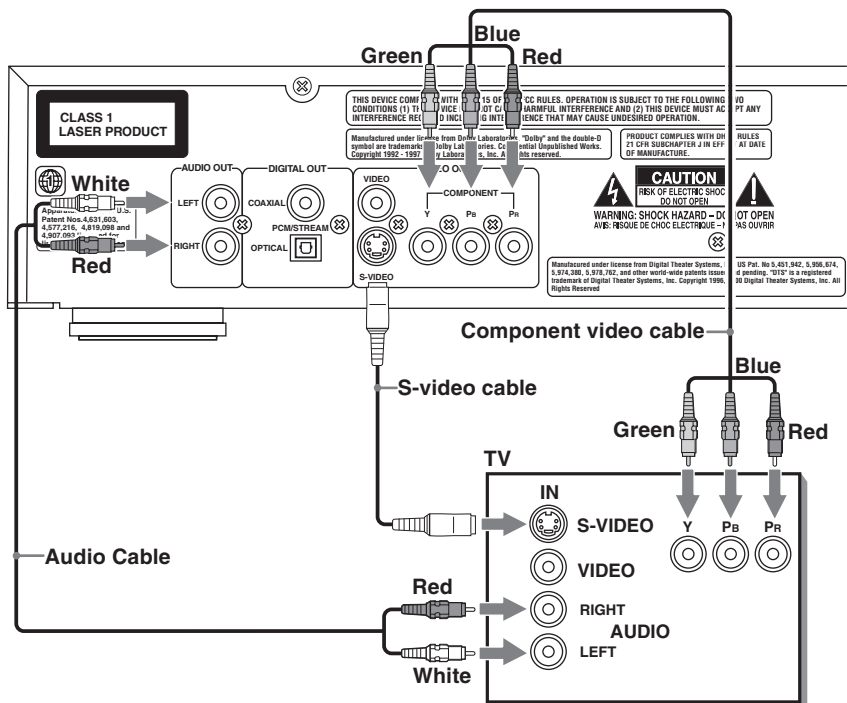
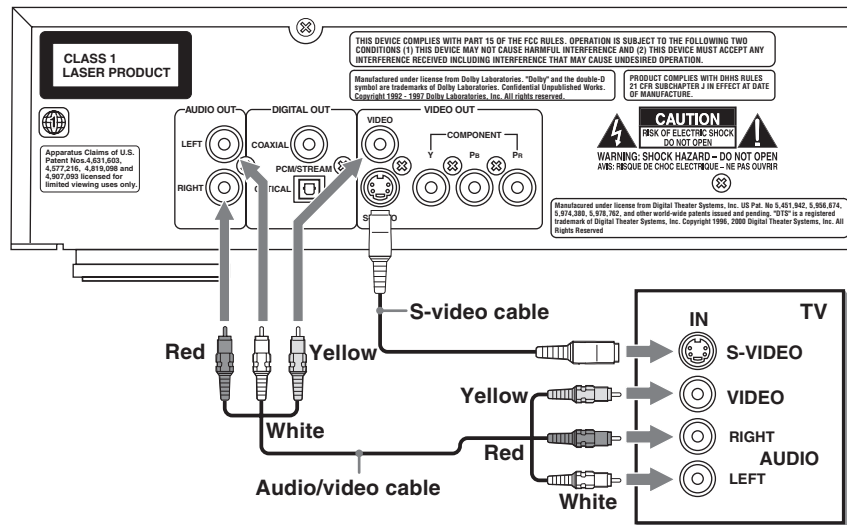

NOTE: When the Component Video outputs are connected to an NTSC television you may be able to use the Progressive Scan mode of the RDV-1040 which produces a picture with less flicker. See the Remote/480p/480i Output Signal Selector Switch section. Not applicable to PAL televisions.

Connecting to Audio Equipment with a Digital Input

You can enhance the sound quality by connecting the OPTICAL DIGITAL OUTPUT **13** or COAXIAL DIGITAL OUTPUT **14** of the RDV-1040 to the digital input of an amplifier, DAT or MD by using an optional digital cable. The digital stereo audio signal from a disc is directly transferred. If you connect the unit to a Dolby Digital or DTS decoder or an amplifier with built-in decoder by using an optional digital cable, you can enjoy high-quality surround sound.

When you make the digital connection, also make the analog connection, because, depending on the disc type, no audio may be reproduced from the DIGITAL OUTPUT.

With the digital connection, the Preference menu settings for COMPRESSION and DOWN MIX are disabled. Settings for these items must be made from the decoder.

IMPORTANT NOTE ABOUT DIGITAL SIGNAL CONNECTION:

The Digital Audio Output setting in the Audio Preferences on screen display **must** be properly set for the type of output being used when using an optical or coaxial digital signal connection. If this preference setting is not done correctly, loud noise may be generated which can damage the speakers. Before using the RDV-1040 with a digital signal connection be sure the proper type of Digital Audio Output has been selected. See the Audio Menu information in the Preferences Setting section of this manual.

Connecting to an Audio Amplifier or Receiver

You will get better sound quality if you connect the audio outputs of the RDV-1040 to a high quality amplifier or receiver and use component loudspeakers, rather than those built into the television.

Connect the AUDIO OUTPUTS **12** of the RDV-1040 to any high level input (such as AUX, DVD, CD, etc.) of an amplifier or receiver.

Optical Connection

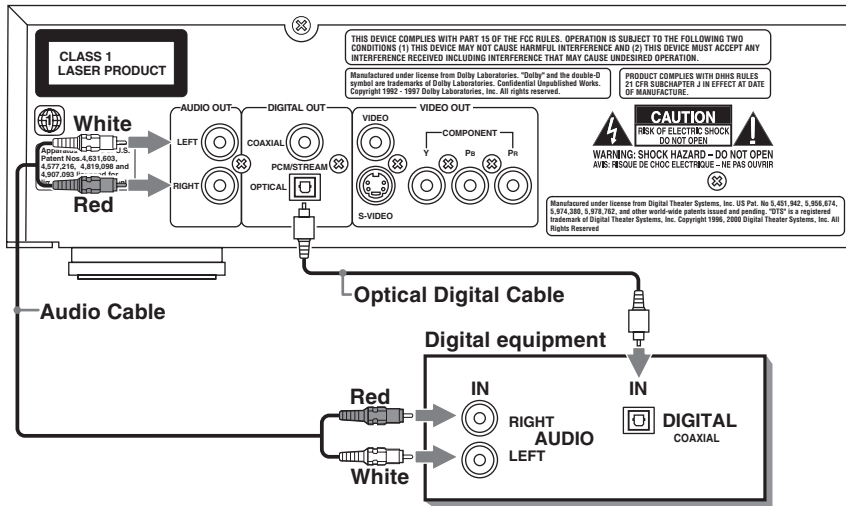

Coaxial Connection

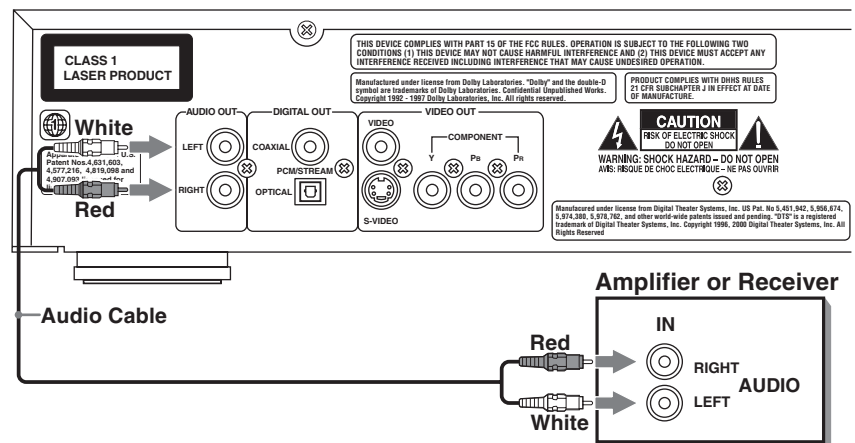
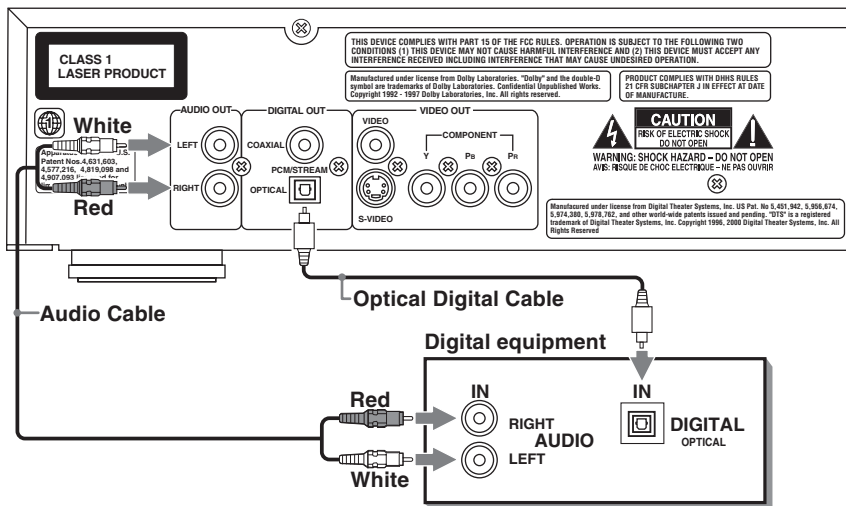

Connecting the Power Cord

AC Input 21

Your RDV-1040 is configured at the factory for the proper AC line voltage in the country where you purchased it (USA: 115 volts/60Hz AC or CE: 230 volts/50Hz AC). The AC line configuration is noted on a decal on the back of your unit.

After all the audio/video connections have been made, plug the supplied power cord into the AC INPUT receptacle on the back of the unit. Then insert the power plug into an AC wall outlet. The STANDBY indicator lights and setup is complete. Note that a small amount of power (3 watts) is always used while the power cord is connected to the wall outlet.

Observe the following precautions:

- Do not connect or disconnect the power cord with wet hands.
- Disconnect the power cord if you are not going to use the unit for a long time.
- When unplugging the player from the wall outlet, always pull the plug, not the power cord.
- Disconnect the power cord before cleaning the unit.
- Disconnect the power cord before moving the unit.
- Do not damage, alter, twist or pull the power cord. This may damage the cord and cause fire, electric shock, or other accidents. Contact your authorized Rotel dealer and get a new power cord if the cord is damaged.
- Do not put anything heavy, on the unit, or the power cord, as this may cause fire, electric shock, or other accidents.

RR-DV96 Remote Control

Installing the Batteries

The battery compartment is located on the back of the remote control unit.

- 1 Press down on the point shown by the arrow at the top of the compartment cover, and pull up the cover.

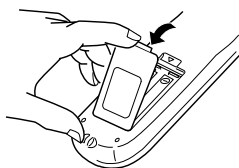

- 2 Place two R6P (SUM-3)/AA(1.5F) batteries in the remote control according to the polarity markings (“+” and “-”) inside the compartment and on the batteries.

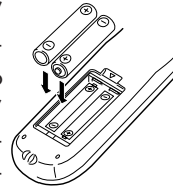

- 3 Place the cover over the compartment, and press down lightly.

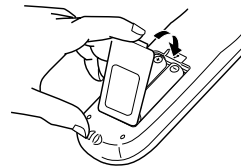

The batteries will last about six months with normal use. If the functions of the remote control become erratic, replace the batteries.

Precautions for the safe use of batteries

Observe the following precautions for the safe use of batteries. If they are used improperly their life will be shortened, they may burst or their contents may leak.

- Remove the batteries from the remote control if it will not be used for a long period of time.
- Remove dead batteries and dispose of them properly.
- Never leave dead batteries lying around. Do not take them apart, mix them with other refuse, or throw them into an incinerator.
- Never touch liquid that has leaked out of a battery.
- Do not mix new and old batteries, or batteries of different types, when replacing them.

Programming the RR-DV96 Remote to Control a TV

After it is programmed the RR-DV96 can operate your TV set.

- 1 Set the TV/DVD switch 1 to TV.
- 2 Press and hold down the TV/VIDEO-CANCEL 22 button. Then enter the manufacturer code of your TV listed in the following table using the numeric buttons (0 - 9) 4. Do not release TV/VIDEO-CANCEL button until the next step is completed. (Example: To enter code “01” press and release the “0” button, then press and release the “1” button.
- 3 Press the ENTER 34 button, then release the TV/VIDEO-CANCEL button.

- 4 Test the program setting by pressing the TV POWER 17 button to see if it turns your set on. If there is more than one code listed for the manufacturer of your TV, try them one by one until you succeed.

Manufacturer	No.	Manufacturer	No.
Aiwa	36	NEC	20
Beijing	22	Noblex	22
CCE	02	Nokia	31
Changhong	34	Panasonic	04, 11
Daewoo	17, 37	Peony	34, 38,
Ferguson	27		39
Finlux	30	Philco	10, 17,
Funai	32		21
Gradiente	15, 20	Philips	02
Grundig	19	RCA	05
Hitachi	10	Samsung	12, 33,
ITT	28		34, 35
Jinxiing	38	Sanyo	13, 16
JVC	01, 23,	Sears	13
	24, 25	Sharp	06
Konka	40	Sony	07
LG (Goldstar)	18	TCL	41
Magnavox	02	Thomson	26
Mitsubishi	03	Toshiba	08, 14
Mivar	29	Zenith	09

Remote Control TV Operation

When the TV/DVD switch 1 is in the TV position the following buttons can be used to control the TV.

TV POWER 17

Turns the TV on or off.

CH+ and CH - 31 13

Changes the TV channels.

VOL+ and VOL - 32 12

Adjusts the TV volume.

TV/VIDEO button 22

Switches the TV input between TV and Video.

0 - 10 and (Numeric Buttons) 4

Selects the TV channels. Note: For some TVs, pressing “+10” functions as the “+100”. The “10” button functions as ENTER if your TV requires pressing the ENTER after selecting a channel number.

MUTING button 21

Mutes the TV sound.

External Remote In 18

The 3.5mm mini-jack (labeled EXT REM IN) receives command signals from an industry standard infrared receiver. This feature is useful when the unit is installed in a cabinet and the front panel sensor is blocked. Consult your authorized Rotel dealer for information on external receivers and the proper wiring of a jack to fit the mini-jack receptacle.

Playable Discs

This unit can play the following types of discs:



The RDV-1040 can also play back the following discs:

- DVD-R and DVD-RW discs written in the DVD VIDEO format and finalized.
- CD-R and CD-RW discs written in the SVCD, Video CD or Audio CD format and finalized.
- CD-R and CD-RW discs written in MP3 or WMA in accordance with the "ISO 9660" format.
- CD-R and CD-RW discs written in JPEG in accordance with the "ISO 9660" format.

The RDV-1040 can play back audio signals recorded in MIX-MODE CD, CD-G, CD-EXTRA and CD TEXT.

NOTE: If a disc is dirty, scratched or warped, or has unusual disc or recording characteristics, it may take considerable time for the RDV-1040 to read the disc contents. In some instances the RDV-1040 may not be able to play certain discs.

DVD Video Disc Region Codes

All DVD players and DVD discs have a Region Code number. This unit only can play back DVD discs whose Region Code numbers include the unit's Region Code, which is indicated on the region code symbol on the rear panel.

Examples of playable DVD discs for a unit with Region Code "1"



NOTE: With some DVD and Video CD discs, you may not be able to control them according to the instructions described in this manual, because of the contents of the disc.

This RDV-1040 accommodates the PAL system, and also can play back discs recorded with NTSC system whose Region Code numbers include "2." Note that the NTSC video signal on a disc is converted to a PAL signal and output.

Unplayable Discs

The RDV-1040 does not play back discs listed below. **If you try to play back these discs, noise may generate causing damage to speakers.**

- DVD-RW discs written in the VR format
- DVD-ROM, DVD-RAM, DVD AUDIO, CD-ROM, PHOTO CD, SACD

In addition, the RDV-1040 does not play:

- Unfinalized discs
- Discs of irregular shape or discs with tape, seals or adhesives on either the label side or playback side. **Playing back these discs may damage the RDV-1040.**

Digital Audio Formats

The RDV-1040 supports the following digital audio formats (see the Glossary for descriptions of each audio format):

Linear PCM, MPEG Multichannel, Dolby Digital, DTS (Digital Theater Systems)

NOTE: Depending on the Digital Audio Output setting of the RDV-1040, digital audio signals may not be output as they are recorded on the disc. See Digital Audio Output section of this manual for details.

Notes on Discs

- With some DVD VIDEO discs, the RDV-1040 starts playback automatically after inserting the disc.
- The image may be sometimes poor or noisy due to defects in the disc itself.
- With some discs, operations described in this manual may not be possible.

Disc Care and Handling

Proper handling and storage of discs is very important. If a disc gets dirty, dusty, scratched or warped, playback, sound and picture will be adversely affected.

Handling

- To avoid damage do not touch the surface of the disc.
- Do not apply labels or use any adhesive on either the label side or playback side.

Storing discs

- Keep discs in their cases. If discs are piled on top of one another without their protective cases, they can be damaged.
- Do not put discs where they may be exposed to direct sunlight, or high temperatures or humidity. Avoid leaving discs in a car!

Cleaning discs

- Wipe with a soft dry cloth, moving from the center outwards. If a disc is difficult to clean, wipe with a cloth moistened with water.
- Never use record cleaners, petrol, alcohol or any anti-static agents.

NOTES ON COPYRIGHT: Check the copyright laws in your country before recording from DVD VIDEO, SVCD, Video CD, Audio CD, MP3, WMA and JPEG discs. Recording of copyrighted material may infringe copyright laws.

This product incorporates copyright protection technology that is protected by method claims of certain U.S. patents and other intellectual property rights owned by Macrovision Corporation and other rights owners. Use of this copyright protection technology must be authorized by Macrovision Corporation, and is intended for home and other limited viewing uses only unless otherwise authorized by Macrovision Corporation.

Reverse engineering or disassembly is prohibited.

Getting Started

Turning On the RDV-1040

With the TV/DVD switch **1** set to DVD press the DVD POWER button **16** on the RR-DV96. Or press the STANDBY **1** button on the front panel. The STANDBY/ON indicator on the front panel, which lights in red during standby, changes to green, and the left and right sides of the display window are illuminated.

The opening display appears on the TV screen.



The following messages may appear at the bottom of the opening display.

- NOW READING (The RDV-1040 is reading the disc information.)
- REGION CODE ERROR! (The region code of the DVD VIDEO disc does not match the RDV-1040. The disc cannot be played.)
- OPEN
- CLOSE
- NO DISC

NOTE: Even if you turn off the RDV-1040 it is not disconnected from the AC power source as long as it is connected to the wall outlet. This state is called standby mode. In this state, the unit consumes a very small amount of power.

NOTE - Invalid Operation Icon: With some discs the RDV-1040 may not be able to perform certain operations. For example, some discs may not allow rapid advance/reverse or slow motion playback. When you press a remote control or front panel button if the RDV-1040 cannot perform the operation the  Invalid Operation icon appears on your TV screen. Operations are occasionally unacceptable even if it is not displayed.

Initial Setup

When you turn on the RDV-1040 for the first time, the following message appears on the TV screen.

EXECUTE DVD PLAYER SETUP?
BASIC PICTURE/AUDIO SETTING
YES - PRESS ENTER NO - CANCEL

You can set the display language, TV monitor type and digital output before using the RDV-1040, by using the following procedures.

1 Press ENTER **34.** The first page of the DVD PLAYER SET UP display appears. The pull-down menu of the ON SCREEN LANGUAGE is already open.

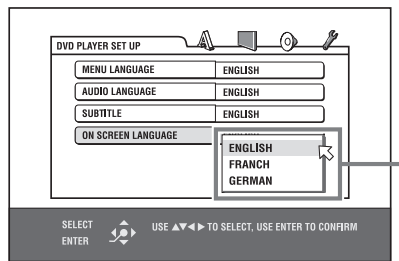

ON SCREEN LANGUAGE options

2 Press $\blacktriangle/\blacktriangledown$ to select the desired language. You can select the on-screen language for the preference displays, etc. from among ENGLISH, FRENCH and GERMAN.

3 Press ENTER **34.** The second page is shown. The pull-down menu for the MONITOR TYPE is already open.

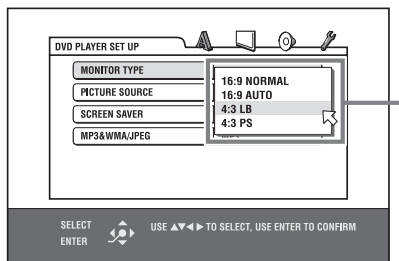

MONITOR TYPE options

4 Press $\blacktriangle/\blacktriangledown$ to select the desired monitor type. For a normal (conventional) TV, select 4:3 LB or 4:3 PS. For a wide-screen TV, select 16:9 NORMAL or 16:9 AUTO.

5 Press ENTER **34.** The third page is shown. The pull-down menu of the DIGITAL AUDIO OUTPUT is already open.

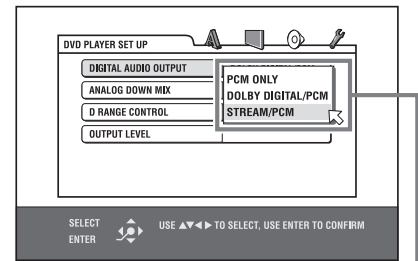

DIGITAL AUDIO OUTPUT options

6 Press $\blacktriangle/\blacktriangledown$ to select a desired digital output signal type. If you connect the RDV-1040 to an external surround decoder or D/A converter set this as needed.

- When connecting to a Dolby Digital decoder, select DOLBY DIGITAL/PCM.
- When connecting to a DTS decoder, select STREAM/PCM.
- When connecting to other digital devices, select PCM ONLY.

7 Press ENTER **34.** The TV screen returns to the opening display.

Recalling the DVD PLAYER SET UP menu

Press CHOICE for a few seconds until the DVD PLAYER SET UP display appears.

Changing the Display Window Brightness

Press DIMMER on the remote control unit. You can select the display window brightness from three levels, or off. If the brightness is set to off, nothing will be shown on the display.

Basic Disc Play



- 1 Press the OPN/CLS button **8** on the front panel or the OPEN/CLOSE button **2** on the remote control to open the disc tray.
- 2 Place a disc in the disc tray.

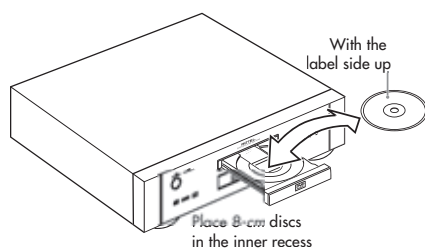

- 3 Press **3**. The RDV-1040 starts playback from the beginning.

To stop disc play press **■** (STOP) **9 9**. To pause disc play press **⏸** (PAUSE) **27 10**. To resume playback, press **▶** (PLAY) **28 7**.

NOTES: Do not insert an unplayable disc. (See Playable Discs section.)

When placing a disc on the disc tray, be sure to set it in the recess. Otherwise, the disc may be damaged when the disc tray is closed, or you may not be able to remove the disc from the RDV-1040.

On-Screen Menu

After loading a DVD VIDEO, SVCD or Video CD disc, a menu may appear on the TV screen. From the menu, you can select an item to be played.

For DVD VIDEO

- 1 Press **▲▼◀▶** **31 13 12 32** to select an item.
- 2 Press **ENTER** **34**. The RDV-1040 starts playback of the selected item.

For SVCD/Video CD

Press the numeric buttons to select an item. The RDV-1040 starts playback of the selected item.

On Screen Icons

During disc playback, you may see icons displayed over the picture. These have the following meanings.

– Is displayed at the beginning of a scene recorded from multiple angles. See the Selecting a Scene Angle section.

– Is displayed at the beginning of a scene recorded with multiple audio languages. See the Changing the Audio Language or Sound section.

– Is displayed at the beginning of a scene recorded with multiple subtitle languages. See the Selecting the Subtitle Language section.

About PBC (Playback Control)

Some SVCD/Video CD discs support the PBC function. The PBC function allows you to enjoy menu-driven operation and high-resolution still images which have a resolution four times greater than moving pictures.

- To play a PBC-compatible SVCD/Video CD disc without activating the PBC function, press the Numeric buttons **4** instead of **▶** (PLAY) **28** to start playback.
- To activate the PBC function again: Press **TOP MENU** **11** or **MENU** **30**, or Press **■** (STOP) **9 9** to stop playback, then press **▶** (PLAY) **28**.

To Check Playback Status

Press **ON SCREEN** **33** to see the current selection number (the title/chapter number for DVD VIDEO or track number for SVCD/Video CD/ Audio CD), time information (the track or chapter time while stopped, or elapsed track or chapter time during playback) and the transport status (stop, playback, pause, etc.) on the TV screen.

Example: for DVD VIDEO

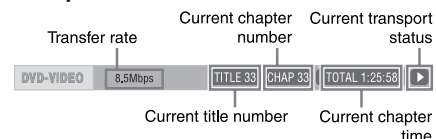

Pressing **ON SCREEN** again brings up the menu bar under the status bar, from which you can access various functions. See the Menu Bar section of this manual for more information.

To turn off the status bar press **ON SCREEN** repeatedly until the status bar goes off.

Resuming Playback

The RDV-1040 can remember the position on a disc where you interrupt playback and resume playback from that position later. There are three resume modes; ON, OFF and DISC RESUME. The mode is set at the factory to ON. You can select the mode using the Preference settings.

When the Resume Mode is ON

When you press **■** (STOP) **9 9** the RDV-1040 stops playback and remembers the position where playback was interrupted. The TV screen shows RESUME STOP and the RESUME indicator lights up in the display window. The remembered position where playback is interrupted is not cleared if you turn off the RDV-1040.

When you turn off the RDV-1040 after setting the resume function, simply press **▶** (PLAY) **28 7**. The RDV-1040 is turned on, and playback starts from the interrupted position. If you turn on the RDV-1040 by pressing **STANDBY** button **1** then press **▶** (PLAY), playback starts from the beginning of the disc. Note that the remembered position is cleared if you open the disc tray.

When the Resume Mode is DISC RESUME

When you press **■** (STOP) **9 9** the RDV-1040 stops playback and remembers the interrupted position. The TV screen shows RESUME STOP and the RESUME indicator lights up in the display window. The memory of the interrupted position is not cleared if you open the disc tray or turn off the RDV-1040.

NOTE: The RDV-1040 memorizes interrupted positions for the last 30 discs played. Storing a new interrupted position will erase the interrupted position stored for the first disc.

To clear the memory

Press **■** (STOP) **9 9** while disc play is stopped.

To Resume Playback

When the resume mode is ON

While the disc that you interrupted playback of is still on the disc tray, press ► (PLAY) **28 7**. The RDV-1040 resumes playback from the position where playback was interrupted. The TV screen shows RESUME PLAY.

To play back from the beginning of the disc ■ (STOP) **9 9** before pressing ► (PLAY) **28 7**.

When the resume mode is DISC RESUME

Press the OPN/CLS button **8** on the front panel or the OPEN/CLOSE button **2** on the remote control to open the disc tray and insert a disc for which the RDV-1040 has stored an interrupted position. The TV screen shows RESUME STOP.

Press ► (PLAY) **28 7**. The TV screen shows RESUME PLAY and the RDV-1040 resumes playback from the position where playback was interrupted.

To play back from the beginning, after inserting the disc, press ■ (STOP) **9 9** before pressing ► (PLAY) **28 7** to start playback.

NOTES:

If you change the RESUME setting from DISC RESUME to OFF or ON, you cannot resume playback of a disc whose "resuming" position is stored. However, when you reset RESUME to DISC RESUME, you will then be able to resume playback of the disc.

If you interrupt the playback of a disc for which an interrupted position has already been stored, the memory will be updated with the new interrupted position.

For a double-sided DVD VIDEO disc, the RDV-1040 regards each side as a different disc. Therefore, to resume playback of such a disc, the disc must be inserted with the same side down.

When the RDV-1040 memorizes an interrupted point for a disc, it also memorizes Audio, Subtitle and Angle settings.

The RDV-1040 may not resume playback exactly from the interrupted point. In the case of an SVCD/Video CD disc with PBC function, the RDV-1040 may resume playback from a point slightly earlier or later than the point where playback was interrupted.

Various Speed Playback

To Rapidly Advance or Reverse Playback



During playback, press ►► **29** or ◀◀ **10** on the remote control unit. You can select from 1.5 times, 5 times, 20 times and 60 times normal speed. Pressing ► (PLAY) **28 7** returns the RDV-1040 to normal playback.

During playback, hold down ◀◀ **8** or ►► **26**. Playback is advanced or reversed at 5 times normal speed.

During rapid playback, the sound is muted except when playing an Audio CD, and when playing a DVD VIDEO or Video CD at 1.5 times normal speed. For Audio CD discs, the sound is heard intermittently.

1.5x Quick Playback With Sound



When you select 1.5 times normal speed playback, the disc is played back with sound.

- For DVD VIDEO discs, the subtitles remain on.
- If the sound of a DVD VIDEO disc is recorded in Dolby Digital or DTS format, stereo linear PCM signals are output. With some DVD VIDEO discs, the sound quality and volume may be altered, or the sound may be out of tune.
- To switch from rapid reverse playback to x1.5 Quick Playback, first press ► (PLAY) **28 7**, then press ►► **29** once.

To Advance a Still Picture Frame by Frame



With disc play paused, press || (PAUSE) **27 10**. Each time you press || (PAUSE), the still picture advances to the next frame. Press ► (PLAY) **28 7** to return to normal playback.

To Play Disc in Slow Motion



You can select from 1/32 times, 1/16 times, 1/4 times and 1/2 times normal speed.

During playback, press || (PAUSE) **27**, then press ►► **29** (to play forward slow motion), or ◀◀ **10** (to play reverse slow motion, for DVD VIDEO disc only). Pressing ► (PLAY) **28** returns to normal playback.

- During slow motion playback, the sound will be muted.
- Reverse slow motion playback is not possible for an SVCD and Video CD.

Locating the Beginning of a Scene or Song



For DVD VIDEO: During playback, you can skip a chapter or title, depending on the disc configuration.

For SVCD/Video CD: During playback without PBC function, you can skip a track –

For Audio CD: During playback or while in stop mode, you can skip a track –

To skip forward, press ►► **26 11**.

To skip backward, press ◀◀ **8 11**.

Using the Numeric Buttons

For DVD VIDEO/Audio CD: During playback or while in stop mode –

For SVCD/Video CD: During playback without PBC function or while in stop mode –

Press the numeric buttons to specify the number.

Examples:

To select 5: press 5.

To select 23: press +10, +10, then 3.

To select 40: press +10, +10, +10, then 10.

The RDV-1040 starts playback from the beginning of the selection.

Depending on the disc type and the status of the RDV-1040, what is specified differs:

Player status	Disc type	What is Specified
While stopped	DVD VIDEO	title
	SVCD/Video CD/Audio CD	track
During playback	DVD VIDEO	chapter
	SVCD/Video CD/Audio CD	track

During DVD VIDEO playback, if a menu is shown on the TV screen, the numeric buttons may be used for selecting an item in the menu.

Screen Saver Function

If a static image is displayed on a television monitor for a long period of time the image can be “burned into” the screen. To prevent this, the RDV-1040 automatically activates the screen saver function if a static image, such as an on-screen display or menu, is displayed for over 5 minutes. When the screen saver function is activated, the TV screen gets darker. Pressing any control button will restore normal operation.

Advanced Operations

Make sure that the TV/DVD switch **1** on the remote control is set to “DVD” when using the **▲▼◀▶**, numeric and TV/VIDEO - CANCEL buttons for controlling the RDV-1040.

Playing From a Specific Position

Locating a Scene From the DVD Menu



DVD VIDEO discs generally have their own menus which show the disc contents. These menus contain various items such as titles of movies, names of songs, or artist information, and display them on the TV screen. You can locate a desired scene using the DVD menu.

1 While a DVD video disc is loaded, press TOP MENU **11** or MENU **30**. The menu appears on the TV screen.

2 Press **▲▼◀▶** **31** **13** **12** **32** to select an item, then press ENTER **34**. The RDV-1040 starts playing the selected item.

The MENU button does not work while stopped.

NOTES:

Some DVD VIDEO discs may also have a different menu which appears when MENU is pressed.

See the instructions of each DVD VIDEO disc for its particular menu.

With some discs, you can select items by entering the corresponding number using the numeric buttons, which may cause the RDV-1040 to automatically start playback.

Locating a Scene From the Menu of a SVCD/Video CD with PBC



Some SVCD/Video CD discs support the PBC function. PBC is an abbreviation of “Playback Control.” Some SVCD/Video CD discs recorded with PBC have their own menus, such as a list of the songs on the disc. You can locate a specific scene by using the PBC menu.

1 In stop mode, press **▶** (PLAY) **28** or TOP MENU **11**. A disc menu appears on the TV screen.

2 Press the numeric buttons **4** to select the desired item.

Examples:

To select 5: press 5.

To select 23: press +10, +10, then 3.

To select 40: press +10, +10, +10, then 10.

The RDV-1040 starts playback of the selected item. To return to the menu, press RETURN **18**.

NOTE: *If something like NEXT or PREVIOUS appears on the TV screen, pressing **▶▶** advances to the next page, and pressing **◀◀** returns to the previous page.*

Specifying a Title



1 During playback, press TITLE/GROUP **7**. [—] is shown in the title display area of the display window.

2 Press the numeric buttons **4** to specify a title to be played.

Examples:

To select 5: press 5.

To select 23: press +10, +10, then 3.

To select 40: press +10, +10, +10, then 10.

The RDV-1040 starts playback from the specified title.

NOTE: *This function may not work with some DVD VIDEO discs.*

Locating a Position in the Current Title or Track (Time Search)



You can play a disc from a certain position by specifying the time from the beginning of the current title (for DVD VIDEO) or the disc (for SVCD/Video CD/Audio CD).

For DVD VIDEO/Audio CD: During playback or while in stop mode –

For SVCD/Video CD: In any condition except SVCD/Video CD playback with PBC –

1 Press ON SCREEN **33** twice. The menu bar appears on the TV screen.

Repeat Playback

To Repeat the Current Selection or All Tracks



For DVD VIDEO: During playback –

For SVCD/Video CD/Audio CD: In any condition except SVCD/ Video CD playback with PBC –

Press REPEAT **3**. If you press REPEAT in stop mode, press **▶** (PLAY) **28** to start playback.

Each time you press REPEAT, the repeat mode cycles among All Repeat, Repeat 1 and Off.

The indication on the display window shows the selected repeat mode.

: Repeats the current title for DVD VIDEO or all tracks for SVCD/Video CD/Audio CD.

: Repeats the current chapter for DVD VIDEO or the current track for SVCD/Video CD/Audio CD.

No indication: The repeat mode is off.

A window which indicates the current repeat mode will be displayed on the TV screen. The mode indication on the window is the same as the one on the menu bar.

Repeat mode example on the TV screen



To Stop Repeat Playback

Press **■** (STOP) **9 9**.

When a DVD VIDEO disc is set, the RDV-1040 stops playback and quits the repeat mode. When an SVCD, Video CD or Audio CD disc is set, the RDV-1040 stops playback but does not quit the repeat mode.

To Quit Repeat Playback

Press REPEAT **3** until the repeat mode indicator goes off in the display window.

NOTES: When the program playback mode is active with an SVCD, Video CD or Audio CD, the repeat mode changes in the same manner.

Note, however, that in the mode the RDV-1040 repeats all the programmed tracks instead of all tracks on the disc.

The repeat playback may not work with some discs, even if you select one of the repeat modes.

To Repeat a Specified Part (A-B repeat playback)



First make sure: The RDV-1040 is in playback mode except SVCD/Video CD playback with PBC.

- 1 Press ON SCREEN **33** twice. The menu bar appears on the TV screen.
- 2 Press **◀/▶** to move to , then press ENTER **34**. The pull-down menu for repeat mode selection appears.
- 3 Press **▲/▼** to select A-B.
- 4 Press ENTER at the beginning of the part you want to repeat (point A). The pull down menu disappears. The repeat icon A- shows.
- 5 Press ENTER at the end of the part you want to repeat (point B). The repeat icon A-B shows. The RDV-1040 locates "A" and starts repeat playback between "A" and "B." The indicator lights in the display window.

To Quit A-B Repeat Playback

Press **◀/▶** to move to A-B , and press ENTER **34**. The A-B repeat mode turns off, then normal playback continues.

NOTE: The A and B points must be set in the same title/track.

Changing the Language, Sound and Scene Angle

Selecting the Subtitle Language (SUBTITLE)



Some DVD VIDEO and SVCD discs contain more than one subtitle language. You can choose a desired one from them. At the beginning of the part where the subtitles are recorded, appears on the TV screen (except when the ON SCREEN GUIDE preference is set to OFF).

- 1 During playback, press SUBTITLE **5**. The subtitle selection window appears on the TV screen.

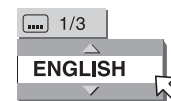

- 2 Press **▲/▼** or SUBTITLE to select the subtitle. Each time you press **▲/▼** or SUBTITLE, the subtitle language changes.
- 3 Press ENTER **34**. Subtitles are displayed in the selected language. The subtitle selection window is dismissed.

NOTES: An SVCD disc can have up to four subtitles. Pressing **▲/▼** cycles through those channels regardless of whether the subtitles are recorded or not.

The subtitle selection window will automatically disappear if you do not change the subtitle for several seconds.

For DVD VIDEO, the selected language may be abbreviated on the TV screen. See "Appendix B: Table of languages and their abbreviations".

Changing the Audio Language or Sound (AUDIO)



The audio selection setting allows you to change the audio language of a movie, or to listen to karaoke with or without the vocal. At the beginning of the part where multiple audio tracks are recorded, appears on the TV screen (except when the ON SCREEN GUIDE preference is set to OFF).

1 During playback, press AUDIO **23**. The audio selection window appears on the TV screen.

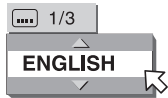

2 Press ▲/▼ or AUDIO to select the desired audio. Each time you press ▲/▼ or AUDIO, the audio changes.

For DVD VIDEO (example)

1/3 ENGLISH ↔ 2/3 FRENCH ↔ 3/3 GERMAN

For SVCD

ST1 ↔ ST2 ↔ L-1 ↔ R-1 ↔ L-2 ↔ R-2

For Video CD

ST (Stereo) ↔ L ↔ R

3 Press ENTER **34**. The selected audio is heard and the audio selection window disappears.

NOTES: The audio selection window will automatically disappear if you do not change the audio within several seconds.

For DVD VIDEO, the selected language may be abbreviated on the TV screen. See "Appendix B: Table of languages and their abbreviations".

Selecting a Scene Angle (ANGLE)



You can view a variety of scene angles if the DVD VIDEO disc contains "multi-angle" parts, where multiple cameras were used to shoot the same scene from different angles. At the beginning of a "multi-angle" part,  appears on the TV screen (except when the ON SCREEN GUIDE preference is set to OFF).

1 During playback, press ANGLE **6**. The angle selection window appears on the TV screen.



2 Press ▲/▼ or ANGLE to select the desired angle. Each time you press ▲/▼ or ANGLE, the angle changes.

3 Press ENTER **34**.

You will see the picture from the selected angle. The angle selection window disappears.

NOTE: The angle selection window will automatically disappear if you do not change the angle for several seconds.

Special Picture/Sound Effects

To Zoom In On Pictures



1 During playback or while paused, press ZOOM **24**. Pressing ZOOM causes the RDV-1040 to zoom in on the image. At the top left of the screen, the information for the current magnification appears for about 5 seconds. Each time you press ZOOM, the magnification is doubled (1.8, 4, 8, 16, 32 and 64 times).

ZOOM x 4



When a picture of a DVD VIDEO disc is viewed on a normal TV screen (4:3, Letter Box), black bars may appear at the top and bottom of the screen. In this case, if you select the "ZOOM x1.8" mode, the black bars become almost invisible. When a 1:2.35 or 1:1.85 DVD VIDEO source is played back, however, the black bars are visible on the screen.

2 Press ▲/▼/◀/▶ to move the zoomed position.

To return to the normal playback press ENTER **34**.

NOTE: When you are zoomed in on a picture the image may look coarse.

To Adjust the Picture Quality (VFP)



The VFP (Video Fine Processor) function allows you to adjust the picture quality according to the type of programming, picture tone or personal preferences.

1 During playback, press VFP **25**. The VFP mode selection window appears on the TV screen.

2 Press ◀/▶ to select the desired preset. Each time you press the button, the VFP mode changes as follows. Set the video type most suitable to the current program or the room conditions.

NORMAL ↔ CINEMA ↔ USER 1 ↔ USER 2

Selected preset

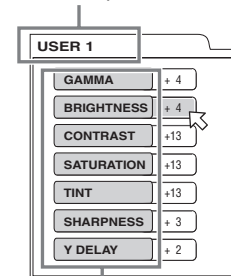

Parameter

NORMAL: for watching TV in a general room.

CINEMA: for watching a movie in a room with suppressed light.

USER 1 USER 2: you can adjust parameters that affect the picture character and store the settings as a user preset. See the next step.

3 To define a user setting, press ▲/▼ to select a parameter to be edited from the following.

GAMMA: Adjust this if the neutral color is bright or dark. The brightness of dark and bright portion is maintained. Available range: -4 (darkest) to +4 (brightest).

BRIGHTNESS: Adjust this if the picture is bright or dark on the whole. Available range: -16 (darkest) to +16 (brightest).

CONTRAST: Adjust this if the far and near position is unnatural. Available range: -16 to +16.

— continued

SATURATION: Adjust this if the picture is whitish or blackish. Available range: -16 (blackest) to +16 (whitest).

TINT: Adjust this if the appearance of flesh tones is unnatural. Available range: -16 to +16.

SHARPNESS: Adjust this if the picture lacks sharpness. Available range: 0 to +3.

Y DELAY: Adjust this if the picture looks separated/overlapped. Available range: -2 to +2.

4 Press ENTER **34**. A window for setting parameters appears.



Selected parameter

5 Press ▲/▼ to adjust the level of the parameter. The higher value enhances the effect.

6 Press ENTER **34**. Repeat steps 3 to 6 if you want to set other parameters.

To turn off the VFP mode selection window press VFP **25**.

NOTE: The window for VFP mode selection and parameter setting disappears if no changes are made within about 10 seconds.

Simulated Surround Sound (VSS)



Using the VSS function, you can get a simulated surround effect from your stereo system.

1 During playback, press VSS **20**. The VSS window appears on the TV screen.

2 Press ◀/▶ to select the desired mode. Each time you press the button, the VSS mode changes as follows:

→ ACTION ↔ DRAMA ↔ THEATER ↔ NONE ←



Selected effect mode

ACTION: Suitable for action movies and sports programs in which the sound source moves.

DRAMA: Natural and warm sound. You can enjoy movies in a relaxed mood.

THEATER: You can enjoy sound effects like in a theater.

3 Press ▲/▼ to adjust the effect level. You can set the effect level from 1 to 5. The higher value enhances the effect.

To turn off the VSS window press VSS **20**.

NOTES: The VSS window disappears if no changes are made within about 10 seconds.

The VSS function works correctly only when playing a DVD Video disc recorded with Dolby Digital.

When playing back a DVD Video disc recorded with Dolby Digital that does not contain the rear channel signal, changing the VSS setting will not produce a true surround sound effect.

The VSS function does not affect the Dolby Digital bitstream signal from the DIGITAL OUT jack.

When the VSS function is active, the ANALOG DOWN MIX setting in the AUDIO setting display is not available.

Menu Bar Functions

To Display a Menu Bar

1 With a disc is loaded, press ON SCREEN **33**. A status bar for the type of disc inserted will appear on the TV screen.

2 Press ON SCREEN again. A menu bar for the type of disc inserted will appear under the status bar.

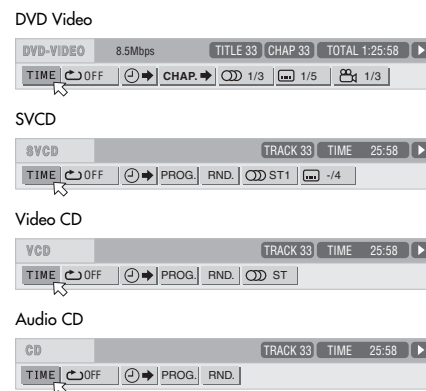

To turn off the menu bar and status bar press ON SCREEN again.

Basic Operation Procedure

1 Press ◀/▶ to select the icon you want to work with. The selected icon is indicated by ↗.

2 Press ENTER. An appropriate pull-down window appears however, there are some exceptions.

NOTES: A mark or text on the menu icon for the function or mode currently selected is shown in green.

Some functions are not available during playback. (You cannot move ↗ to the associated icon when it is not available.)

Menu Bar Functions for DVD VIDEO

Time Mode Selection TIME

During playback, selects the time mode shown in the display window and in the status bar.

Press ENTER **34** to select the time mode from the following.

TOTAL: Current title elapsed time
T.REM: Current title remaining time
TIME: Current chapter elapsed time
REM: Current chapter remaining time

Repeat Mode ↺

Selects the repeat mode during playback.

1. Open the pull-down window.
2. Press ▲/▼ to select the repeat mode from the following.

CHAPTER: Current chapter repeat

TITLE: Current title repeat

A-B: A-B repeat

OFF: Repeat mode deactivated

3. Press ENTER **34** to make the selected repeat function active.

Time Search ⌚

Specifies a time from the beginning of the current title from which to begin playback.

Chapter Search CHAP. ➡

During playback, specifies a desired chapter to be played back from.

1. Open the pull-down window.
2. Press numeric buttons **4** (0 to 9) to enter a desired chapter number. (For example, to specify "10," press 1, then 0.)
3. Press ENTER **34** to begin playback from the specified chapter.

Audio Selection

During playback, selects the audio language or sound track.

1. Open the pull-down window.
2. Press ▲/▼ to select a desired audio language or sound track.
3. Press ENTER **34** to begin playback with the selected audio.

Subtitle Selection

During playback, selects the subtitle language.

1. Open the pull-down window.
2. Press ▲/▼ to select a desired subtitle language.
3. Press ENTER **34** to begin playback with the selected subtitle.

Angle Selection

During playback, selects a scene angle in a multi-angle part.

1. Open the pull-down window.
2. Press ▲/▼ to select a scene angle.
3. Press ENTER **34** to begin playback with the selected scene angle.

Menu bar functions for SVCD/Video CD/Audio CD

Time Mode Selection

Selects the time mode shown in the display window and in the status bar.

Press ENTER **34** to select the time mode from the following.

TIME: Current track elapsed time

REM: Current track remaining time (while in stop mode, current track total time)

TOTAL: Disc elapsed time

T.REM: Disc remaining time (while in stop mode, disc total time)

Repeat Mode

Selects the repeat mode.

1. Open the pull-down window.
2. Press ▲/▼ to select the repeat mode from the following.

TRACK: Current track repeat

ALL: All track repeat

A-B: A-B repeat

OFF: Repeat mode deactivated

3. Press ENTER **34** to make the selected repeat function active.

Time Search

Specifies a time from the beginning of the disc as the point from which to begin playback.

Program Playback

While stopped, specifies the playback order of tracks.

Random Playback

While stopped, activates random playback.

Audio Selection

During SVCD/Video CD playback, selects the audio channel(s).

1. Open the pull-down window.
2. Press ▲/▼ to select a desired audio channel(s).
3. Press ENTER **34** to play back with the selected audio channel(s).

Subtitle Selection

During SVCD playback, selects the subtitle.

1. Open the pull-down window.
2. Press ▲/▼ to select a desired subtitle.
3. Press ENTER **34** to begin playback with the selected subtitle.

Basic MP3 Operations

Make sure that the TV/DVD switch **1** on the remote control is set to "DVD" when using the ▲▼◀▶, numeric and TV/VIDEO - CANCEL buttons for controlling the RDV-1040.

The RDV-1040 can play back MP3 files and WMA files on a home recorded CD-R/RW disc or commercially available CD. We refer to a disc that contains MP3 and/or WMA files as an "MP3/WMA disc" in this manual.

If a disc contains both of MP3/WMA files and JPEG files, you can only play back files of the type selected by the MP3&WMA/JPEG setting in the PICTURE preference display.

About MP3/WMA Discs

On an MP3/WMA disc, each song is recorded as a file (track). Files are sometimes grouped into folders by artists, album, etc.

- Each file is regarded as a track.
- A folder which has one or more files is regarded as a group.
- A folder which does not directly contain any tracks is ignored.
- Files which do not belong to any folder are grouped into "group 1."

- The RDV-1040 recognizes up to 150 tracks per group, and up to 99 groups per disc. If there are files other than MP3/WMA files, they also count in the 150-file total.

Max. 99 groups per disc

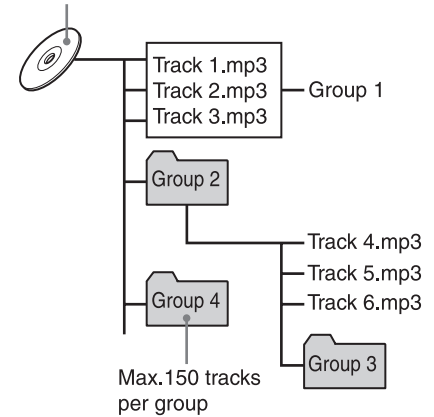

Notes For Making Your Own MP3/WMA Disc Using a CD-R/CD-RW Disc

- Select "ISO 9660" as the disc format.
- For MP3 files, we recommend you record your material at a 44.1 kHz sampling rate, using the 128 kbps data transfer rate.
- For WMA files, make sure that the copyright feature is set to off.
- For WMA files, we recommend you record your material at a bit rate of 64 kbps or higher.

Basic operations

Use the following buttons to control MP3/WMA disc playback.

- ENTER:** Starts playback while stopped.
- ▶:** Starts playback while stopped or paused.
- :** Stops playback.
- ||:** Pauses playback.
- ▶▶** or **◀◀:** Skips back or forward a track during playback. Selects the previous or next track while stopped.

If you press **▶** (PLAY) **28** during playback, or press **■** (STOP) **9** to stop playback followed by **▶**, the RDV-1040 starts playback from the beginning of the current track.

— continued

NOTES:

The RDV-1040 does not support "packet writing (UDF format)" discs.

The RDV-1040 does not support the ID3 tag.

The RDV-1040 supports discs recorded with multiple sessions.

Some discs may not play due to disc characteristics or recording conditions.

Programmed and random playback functions do not work with MP3/WMA discs.

For MP3, the RDV-1040 only can play back tracks with the following file extensions; ".MP3," ".Mp3," ".mp3" and ".mp3."

For WMA, the RDV-1040 only can play back tracks with the following file extensions; ".WMA," ".wma," and any other combination of upper case and lower case letters (such as ".Wma").

Time required for reading the disc contents may vary for different discs, depending on the numbers of groups (folders) and tracks (files) recorded, etc.

You cannot advance or reverse playback by pressing ►► (29) or ◀◀ (10), or by holding down ►► (26) or ◀◀ (8) during MP3/WMA disc playback.

The RDV-1040 supports WMA files recorded with a bit rate of 48 kbps or higher. The RDV-1040 cannot play back WMA files recorded with a bit rate under 48 kbps.

Selecting a Group and Track

When inserting an MP3/WMA disc, after the disc contents are read, the MP3/WMA CONTROL display automatically appears on the TV screen. You can select a group/track from the display using the following procedure.

- 1 Make sure that the black (cursor) bar is in the left (group) column. If it is in the right column, press ◀ to move it to the left column.

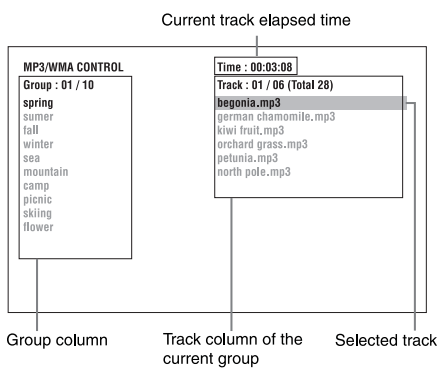

- 2 Press ▲/▼ to move the bar to a desired group. On the right column, tracks in the selected group are shown.

- 3 Press ◀◀ (8) or ►► (26) to select a desired track, then press ENTER (34) or ► (PLAY) (28).

or

Press the numeric buttons (4) to directly specify a desired track number.

Examples:

To select 5: press 5.

To select 23: press +10, +10, then 3.

To select 40: press +10, +10, +10, then 10.

The RDV-1040 starts playback from the selected track.

You can also select a desired track by pressing ► to move the black bar to the right (track) column then using ▲/▼.

NOTES: If an MP3/WMA file name includes any 2-byte character, the RDV-1040 cannot show the file name correctly.

Only MP3/WMA files are shown on the MP3/WMA CONTROL display.

The order of groups/tracks shown in the MP3/WMA CONTROL display may differ from the order shown on your personal computer when you access the disc on your computer.

Direct Selection

You can select a desired group directly by specifying the group number.

- 1 During playback or while stopped, press TITLE/GROUP (7). [—] is shown in the group display area of the display window.
- 2 Press the numeric buttons to specify a desired group number.

Examples:

To select 5: press 5.

To select 23: press +10, +10, then 3.

To select 40: press +10, +10, +10, then 10.

Specify the group number within several seconds after pressing TITLE/GROUP (i.e. while the display window shows [—]). The RDV-1040 starts playback from track 1 of the selected group.

- 3 Press the numeric buttons to specify a track number. The RDV-1040 starts playback from the specified track. You can also use ◀◀/►► or ▲/▼ to specify a track, instead of the numeric buttons.

Repeat Playback

During playback or while stopped, press REPEAT (3). Each time you press REPEAT, the repeat mode changes as follows.

MP3/WMA CONTROL display	Display window	Function
REPEAT TRACK	↺ 1	Repeats the current track.
REPEAT GROUP	↺	Repeats all tracks in the current group.
REPEAT ALL	↺	Repeats all tracks on the disc.
No indication		The repeat mode is off.

On Screen Display

Selected repeat mode

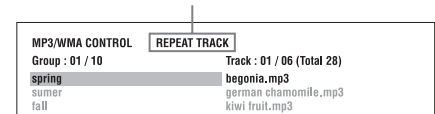

If you press REPEAT while stopped, you need to press ENTER (34) or ► (PLAY) (28) to start repeat play.

To stop repeat playback press ■ (STOP) (9). Note that the repeat mode remains active.

To quit repeat playback -

During playback, press REPEAT (3) until no repeat icon is shown on the display window.

While stopped, press REPEAT until repeat mode indication on the MP3/WMA CONTROL display goes off.

About JPEG Discs

The RDV-1040 can play back JPEG files on a home recorded CD-R/RW disc. We refer to a disc that contains JPEG files as a "JPEG disc" in this manual.

Note that if a disc contains both of MP3/WMA files and JPEG files, you can only play back files of the type selected by the MP3&WMA/JPEG setting in the PICTURE preference display

On a JPEG disc, each picture is recorded as a file. Files are sometimes grouped into folders by category, etc.

- A folder which has one or more files is regarded as a group.
- A folder which does not directly contain any files is ignored.

- Files which do not belong to any folder are grouped into "group 1."
- The RDV-1040 recognizes up to 150 files per group, and up to 99 groups per disc. If there are files other than JPEG files, they also count against the 150-file total.

Max. 99 groups per disc

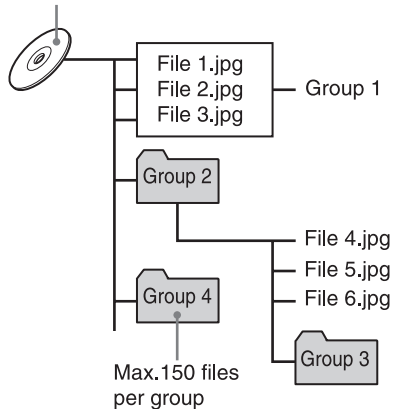

Notes for Making JPEG Disc using a CD-R/CD-RW disc

- Select "ISO 9660" as the disc format.
- Record your material at a 640 x 480 pixel resolution.
- The RDV-1040 supports the baseline JPEG format.

Basic JPEG Operations

To See a Specific Picture

When inserting a JPEG disc, after the disc contents are read, the JPEG CONTROL display automatically appears on the TV screen. You can select a file for viewing with this display.

JPEG CONTROL	
Group : 01 / 10	File : 01 / 06 (Total 28)
Spring	begonia.jpg
summer	german chamomile.jpg
fall	kiwi fruit.jpg
winter	orchard grass.jpg
sea	petunia.jpg
mountain	north pole.jpg
camp	
picnic	
skiing	
flower	

- Make sure that the black (cursor) bar is in the left (group) column. If it is in the right column, press ► (PLAY) 28 to move it to the left column.

- Press ▲/▼ to move the bar to a desired group. On the right column, files in the selected group are shown.

- Press ◀▶/▶▶ to select a desired file, then press ENTER 34. The selected file (still picture) is shown on the TV. If the selected file is unplayable, a black screen appears.

NOTE: You can also select a desired file by pressing ► (PLAY) 28 to move the black bar to the right (file) column then using ▲/▼.

To display another picture press ◀▶/▶▶ or ▲/▼ to select it.

To dismiss the picture press ■ (STOP) 9 or MENU 30. The TV screen returns to the JPEG CONTROL display.

NOTES: The RDV-1040 supports the baseline JPEG format.

The RDV-1040 does not support "packet writing (UDF format)" discs.

The RDV-1040 supports discs recorded with multiple sessions.

The RDV-1040 may not be able to read some discs, or may take a long time to display a picture on the disc, due to disc characteristics, recording conditions, or numbers of groups (folders), etc.

Programmed and random playback functions do not work with JPEG discs.

The screen saver function will be activated if the same picture is displayed for more than 5 minutes except during slide show playback.

The RDV-1040 only can play back files with the following file extensions; ".jpg," ".jpeg," ".JPG," ".JPEG" and any other combination of upper case and lower case letters (such as ".Jpg").

If a JPEG file name includes any 2-byte character, the RDV-1040 may not show the file name correctly.

If a picture has been saved at greater than 640 x 480 pixel resolution, it may take some time to display the picture.

The RDV-1040 does not support pictures of more than 2400 pixels in horizontal resolution. Make sure that the horizontal resolution of the picture is 2400 pixels or less.

To Zoom In on a Picture

- While in pause mode, press ZOOM 24. Each time you press ZOOM, the magnification is doubled (1.8, 4, 8, 16, 32 and 64 times).

- Press ▲/▼/◀/▶ to move the zoomed position.

Viewing Pictures Continuously (Slide Show Mode)

You can see files (still pictures) one after another automatically. To start the slide show ► (PLAY) 28. The slide show starts from the beginning of the disc. Each file (still picture) is displayed for approximately 3 seconds.

To stop slide show playback in the middle press ■ (STOP) 9 or MENU 30. The TV screen returns to the JPEG CONTROL display.

Pressing ► (PLAY) 28 resumes slide show playback from the last picture displayed.

To keep showing the current picture press || (PAUSE) 27 or ENTER 34.

Pressing ► (PLAY) 28 resumes the slide show playback.

To Select the Start Point of the Slide Show

From the JPEG CONTROL display -

- Make sure that the black (cursor) bar is in the left (group) column. If it is in the right column, press ◀ to move it to the left column.
- Press ▲/▼ to move the bar to a desired group.
- Press ◀▶/▶▶ to select a file.
- Press ► (PLAY) 28.

The slide show starts from the specified file.

Direct selection -

- During playback or while stopped, press TITLE/GROUP 7.
- Press the numeric buttons 4 to specify a group number.

Examples:

To select 5: press 5.

To select 23: press +10, +10, then 3.

To select 40: press +10, +10, +10, then 10.

- Press the numeric buttons to specify a file number. The RDV-1040 starts slide show playback from the specified file. If you do not specify a file, the RDV-1040 starts slide show playback from the first file in the group.

Slide Show Repeat Function

In the slide show mode, you can repeat playback of JPEG files in a group or on the disc.

1 While the JPEG CONTROL display is shown, press REPEAT **3**. Pressing REPEAT switches the repeat mode. When the repeat mode is turned on, the  indicator lights in the display window.

The selected repeat mode is shown on the JPEG CONTROL display.

REPEAT ALL: All files on the disc are repeated.

REPEAT GROUP: All files in the current group are repeated.

No indication: The repeat mode is off.

2 Press **▶ (PLAY) 28** to start repeat playback.

To stop repeat playback Press **■ (STOP) 9**. The repeat mode remains active.

To quit repeat playback Press **■ (STOP) 9** or **MENU 30** while the JPEG CONTROL display is shown, then press REPEAT until the repeat mode indication goes off.

Selecting Preferences

This section tells you how to change the Preference Settings. Read this section when you want to connect the RDV-1040 to a wide-vision TV set, or when you want to otherwise change the settings according to your preferences and viewing environment.

About the Preference Display

The Preference display consists of the LANGUAGE, PICTURE, AUDIO and OTHERS setting displays, each having setting items.

Make sure that the TV - DVD switch **1** on the remote control unit is set to "DVD" when using the **▲/▼/◀/▶** and TV/VIDEO - CHANNEL buttons for controlling the RDV-1040.

LANGUAGE

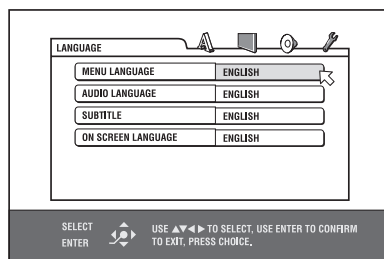

PICTURE

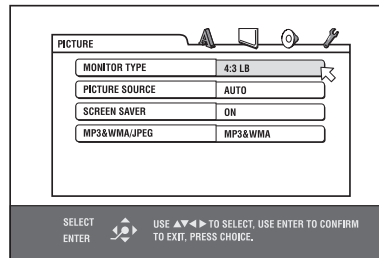

AUDIO

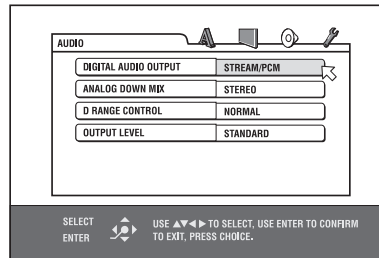

OTHERS

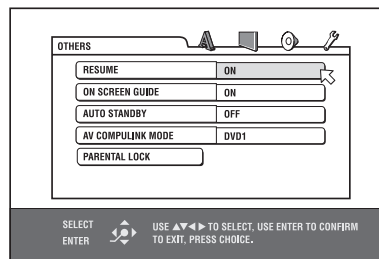

How to Set Preferences

1 Press CHOICE **14**. One of the preference on-screen displays appears on the TV screen. There are four icons at the top right of the on-screen display.

 : LANGUAGE menu

 : PICTURE menu

 : AUDIO menu

 : OTHERS menu

2 Press **◀/▶** to select one of the icons. The corresponding display appears on the TV screen.

3 Press **▲/▼** to select the item you want to edit. The color of the selected item changes.

4 Press ENTER **34**. A pull-down menu appears over the selected item.

5 Press **▲/▼** to select from the options then press ENTER. The selected option is set.

See the following sections for details about each setting.

To turn off the preference display press CHOICE

14.

NOTES: While an MP3/WMA or JPEG disc is inserted, you cannot bring up the preference displays.

When a preference display is shown on a wide TV screen, the upper and lower parts of the preference display sometimes may be cut off. If this happens, adjust the picture size control of the TV.

LANGUAGE Menu

MENU LANGUAGE

You can select the default menu language to be displayed if it is contained on a DVD Video disc.

Setting options: ENGLISH, SPANISH, FRENCH, CHINESE, GERMAN, ITALIAN, JAPANESE, language code from AA to ZU.

If the disc does not have a menu in the selected language, the disc's default language will be used.

For details about language codes, see "Appendix B: Table of languages and their abbreviations".

You cannot change the setting during playback.

AUDIO LANGUAGE

You can select the default audio language to be played if it is contained on a DVD Video disc.

Setting options: ENGLISH, SPANISH, FRENCH, CHINESE, GERMAN, ITALIAN, JAPANESE, language code from AA to ZU.

If the disc does not have the selected language, the disc's default language will be used.

For details about language codes, see "Appendix B: Table of languages and their abbreviations".

You cannot change the setting during playback.

SUBTITLE

You can select the default subtitle language to be displayed if it is contained on a DVD Video disc.

Setting options: OFF, ENGLISH, SPANISH, FRENCH, CHINESE, GERMAN, ITALIAN, JAPANESE, language code from AA to ZU

If the disc does not have a subtitle in the selected language, the disc's default language will be used.

For details about language codes, see “Appendix B: Table of languages and their abbreviations”.

You cannot change the setting during playback.

ON SCREEN LANGUAGE

You can select the on-screen display language of the RDV-1040.

Setting options: ENGLISH, FRENCH, GERMAN

Some on-screen messages are shown in English regardless of the setting.

You cannot change the on-screen language shown on the MP3 display.

PICTURE Menu

MONITOR TYPE

You can select the monitor type to match your TV when you play back DVD VIDEO discs recorded for wide-screen televisions.

Setting options: 16:9 NORMAL, 16:9 AUTO, 4:3 LB, 4:3 PS

16:9 NORMAL (Wide television screen): select when you connect the RDV-1040 to a wide-screen (16:9) TV whose aspect ratio is fixed to 16:9 (the unit automatically adjusts the screen width of the output signal correctly when playing back a 4:3 source).

If you play a 4:3 DVD VIDEO source using the 16:9 NORMAL mode, the picture character changes slightly due to the process for converting the picture width.

16:9 AUTO (Wide television screen): select when you connect the RDV-1040 to a wide-screen (16:9) TV.

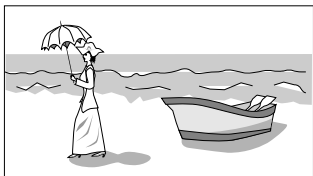

4:3 LB (Letter Box conversion): select when you connect the RDV-1040 to a normal (4:3) TV. When playing back a DVD VIDEO disc recorded in wide picture format, the picture is shown with black bars at the top and bottom.



4:3 PS (Pan Scan conversion): select when you connect the RDV-1040 to a normal (4:3) TV. When playing back a DVD VIDEO disc recorded in wide picture format, the picture is zoomed to fill the screen vertically, and the left and right sides of the image are chopped off. Note, however, that the picture will be shown in the 4:3 LB mode even if you select the 4:3 PS mode depending on the disc.

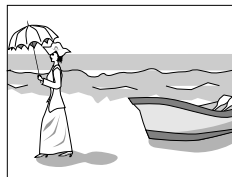

Picture Source

This mode selects whether the content on the disc is processed by field (video source) or by frame (film source). You can obtain optimal picture quality according to the source type to be played back by selecting an appropriate option.

Setting options: AUTO, FILM, VIDEO (NORMAL), VIDEO (ACTIVE)

AUTO: select when playing back a disc containing both video and film source materials. The RDV-1040 recognizes the picture type (film or video source) of the current disc according to the disc information. Normally, select this option.

FILM: select when playing back a film source disc.

VIDEO (NORMAL): select when playing back a video source disc with few movements.

VIDEO (ACTIVE): select when playing back a video source disc with a lot of movement.

Screen Saver

You can turn the screen saver ON or OFF.

Setting options: ON, OFF

MP3 and WMA/JPEG

The RDV-1040 can play MP3/WMA and JPEG files recorded on a CD-R/CD-RW disc. However, if a disc contains both MP3/WMA and JPEG files, you can only play files of the type selected in this menu.

Setting options: MP3 & WMA, JPEG

MP3 & WMA: when selected, only MP3/WMA files can be played back.

JPEG: when selected, only JPEG files can be played back.

AUDIO menu

DIGITAL AUDIO OUTPUT

When you connect the digital output of the RDV-1040 to an external device equipped with a digital input, this item must be set correctly. See “Appendix C: Digital Output Signal Chart” for details about the relation between the setting and output signals.

Setting options: PCM ONLY, DOLBY DIGITAL/PCM, STREAM/PCM

PCM ONLY: select when you connect the DIGITAL OUT jack of the RDV-1040 to the linear PCM digital input of other audio equipment.

DOLBY DIGITAL/PCM: select when you connect the digital input of a Dolby Digital decoder or an amplifier with a built-in Dolby Digital decoder. When this option is selected, playing back a disc recorded by the MPEG Multichannel format outputs a linear PCM digital signal.

STREAM/PCM: select when you connect the digital input of an amplifier with a built-in DTS, MPEG Multichannel or Dolby Digital decoder, or the stand-alone unit of such a decoder.

- With some DVD VIDEO discs that are not fully copy-protected, a 20 or 24 bit digital signal may be output.
- A signal recorded with the 96 kHz or higher sampling frequency is output from the DIGITAL OUT jack with the 48 kHz sampling frequency.

— continued

- When playing a DVD VIDEO or Audio CD disc with DTS, use a DTS decoder to get correct signals from your speakers.

ANALOG DOWN MIX

To correctly play the audio on a DVD VIDEO disc recorded with surround multichannel audio, you must set this item properly according to your audio system configuration. (This function does not work when the VSS function is activated.)

Setting options: DOLBY SURROUND, STEREO

DOLBY SURROUND: select when listening to multichannel surround audio with the analog AUDIO OUT terminals of the RDV-1040 connected to a surround decoder.

STEREO: select when listening to conventional two-channel stereo audio with the AUDIO OUT terminals of the RDV-1040 connected to a stereo amplifier/receiver or television set, or in case you want to record the audio from a DVD VIDEO disc to MiniDisc, cassette, etc.

D. RANGE CONTROL

This setting provides optimal audio quality from the analog AUDIO OUT terminals for listening to DVD VIDEO discs recorded in Dolby Digital format, at low or middle volume.

Setting options: WIDE RANGE, NORMAL, TV MODE

WIDE RANGE: when selected, audio is played back with the widest dynamic range so that you can enjoy powerful playback sound.

NORMAL: normally, select this option.

TV MODE: select if DVD Video disc sound level is lower than TV program sound level. This lets you clearly hear sound at lower volume levels.

OUTPUT LEVEL

This setting allows you to attenuate the level of the signal output from the analog AUDIO OUT terminals of the RDV-1040.

Setting options: STANDARD, LOW

If the sound output from the speaker is distorted, select LOW.

OTHERS Menu

RESUME

You can select the resume playback mode. See the Resuming Playback section for more information.

Setting options: ON, OFF, DISC RESUME

ON: when selected, the RDV-1040 can resume playback of the disc from the position where playback was last interrupted, if the disc is still in the disc tray.

OFF: when selected, the resume function is deactivated.

DISC RESUME: when selected, the RDV-1040 can resume playback of the last 30 discs played. The RDV-1040 retains a memory of the interrupted positions of the last 30 discs played, even though they have been removed from the disc tray.

ON SCREEN GUIDE

The RDV-1040 can display "on-screen guide" icons or characters on the picture, which show what is happening to the disc or the RDV-1040.

Example of "on-screen guide" icons:

Setting options: ON, OFF

ON: when selected, the on-screen guide is activated.

AUTO STANDBY

When the RDV-1040 is stopped for more than 30 minutes or 60 minutes, it enters standby mode automatically.

Setting options: 60, 30, OFF

PARENTAL LOCK



When this option is selected, pressing ENTER on the remote control unit brings up the PARENTAL LOCK display shown below. This allows you to restrict children from playing DVD Video discs.

See the following section for more information about the Parental Lock function.







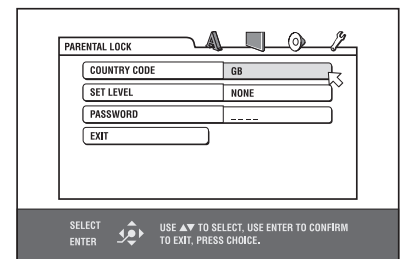

Limiting Playback by Children

This function restricts playback of DVD VIDEO discs which contain violent (and other) scenes according to the level set by the user. For example, if a movie which includes violent scenes supports the parental lock feature, such scenes which you do not want to let children view can be cut or replaced with other scenes.

To Set Parental Lock for the First Time

- 1 Bring up the OTHERS menu.
- 2 Press ▲/▼ to move  to select PARENTAL LOCK then press ENTER . The Parental Lock on-screen display appears on the TV screen.



- 3 While  is pointing to COUNTRY CODE, press ENTER  to bring up the pull-down menu.
- 4 Press ▲/▼ to select the country code. Select the code of the country whose standards were used to rate the DVD Video disc content. See "Appendix A: Country/Area code list for Parental Lock".
- 5 Press ENTER .  moves to SET LEVEL.
- 6 Press ENTER to bring up the pull-down menu. In the pull-down menu, NONE and levels 8 to 1 are available. NONE does not restrict playback. Level 1 is the strictest level. Discs rated higher than the selected level are restricted.
- 7 Press ▲/▼ to select a desired parental lock level, then press ENTER.  moves to PASSWORD.
- 8 Press the numeric buttons  (0 to 9) to enter a 4-digit password.
- 9 Press ENTER . The parental lock feature is set.  moves to EXIT. Pressing ENTER again returns to the OTHERS menu of the preference display.

NOTE: If you want to change the password at step 8, do it before pressing ENTER.

To Change the Settings



You can change the parental lock settings at any time.

- 1 Bring up the OTHERS menu.
- 2 Press ▲/▼ to move to select PARENTAL LOCK and press ENTER **34**. The parental lock on-screen display appears on the TV screen.
- 3 While is pointing to PASSWORD, press the numeric buttons **4** to enter your current 4-digit password then press ENTER **34**. moves to COUNTRY CODE if you enter the correct password. If you enter a wrong password, "WRONG! RETRY..." appears on the TV screen, and you cannot go to the next step. If you forget your password, enter "8888." The current password is deleted and you can set a new password.
- 4 To change the COUNTRY CODE or SET LEVEL, press ENTER **34** to bring up the associated pull-down menu when is pointing to the desired item.
- 5 Press ▲/▼ to select the desired option then press ENTER **34**. If you change the country code, you must reselect the parental lock level.
- 6 While is pointing to PASSWORD, press the numeric buttons to enter a 4-digit password. The password entered in this step becomes the new password. If you want to keep the same password as before, enter the same password.
- 7 Press ENTER **34**. moves to EXIT. Pressing ENTER again returns to the OTHERS menu of the preference display.

NOTE: If you enter the wrong password more than 3 times in step 3 above, moves to EXIT automatically and ▲/▼ do not work.

To Temporarily Release the Parental Lock



If the parental level is set to a strict value, some discs may not play at all. When you insert such a disc and try to play it, the following parental lock on-screen display appears on the TV screen, asking you whether you want the parental lock to be temporarily released or not.

- 1 Press ▲/▼ to move to TEMPORARY RELEASE, then press ENTER.

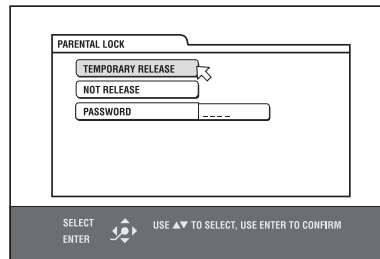

- 2 Press the numeric buttons (0 to 9) **4** to enter your 4-digit password. The parental lock is released, and the RDV-1040 starts playback. If you enter a wrong password, "WRONG! RETRY..." appears on the TV screen. Enter the correct password.

NOTE: When you enter the wrong password 3 times at step 2 above, moves to NOT RELEASE automatically and ▲/▼ do not work.

Troubleshooting

Power

Power does not come on.

- Power plug is not inserted securely. Plug in securely.

Operation

"REGION CODE ERROR!" is shown on the TV screen.

- Region code of the inserted disc does not match the RDV-1040. Check the region code of the disc printed on the disc jacket.

The RDV-1040 does not work.

- Microcomputer malfunction due to lightning or static electricity. Turn off the power and unplug the power cord, then connect the power cord again.
- Moisture condensation caused by a sudden change of temperature or humidity. Turn off the power, then turn it on a few hours later.
- The disc does not allow the operation, or an unplayable disc is inserted. Check and replace the disc. See the Playable Discs section.

LOCK appears in the display window and the disc tray does not open.

- When you press ▲ (OPN/CLS) **8** while pressing down ■ (STOP) **9** when the RDV-1040 in standby mode, the tray lock function is activated. The disc tray cannot be opened or closed in this state. To release the LOCK, press ▲ while pressing down ■ when the RDV-1040 is in standby mode.

Picture

Picture is noisy.

- The RDV-1040 is connected to a VCR directly and the copyguard function is activated. Connect the RDV-1040 directly to the TV.
- With some discs, the picture may be blurred when PICTURE SOURCE is set to FILM or AUTO. Set PICTURE SOURCE to VIDEO (NORMAL) or VIDEO (ACTIVE).

Picture is distorted when using COMPONENT VIDEO OUT or S-VIDEO output jack(s).

- There are connections to both the component and S-video outputs. Disconnect the unused one.

No picture is displayed on the TV screen or the screen is blurred or divided into two parts.

- The RDV-1040 is in the progressive scanning mode but is connected to a TV via the VIDEO or S-VIDEO jack. Set the VIDEO SIGNAL SELECTOR **20** on the rear panel to "480i," or set it to "REMOTE" and make the Progressive scanning mode inactive by using the VFP - PROGRESSIVE SCAN button **25**.

— continued

Audio

DVD VIDEO disc playback sound level is lower than TV broadcast sound level.

- Set the D.RANGE CONTROL preference to TV MODE (see the D. Range Control information in the Preferences Setting section).

Analog audio output is distorted.

- Set the OUTPUT LEVEL preference to LOW (see the Output Level information in the Preferences Setting section).

MP3/WMA

No sound comes out.

- MP3/WMA disc is recorded with the "packet writing (UDF format)." It cannot be played.

Files (tracks) are not played in the recorded order.

- The RDV-1040 plays the files in alphabetic order. So, the playback order can vary.

WMA files cannot be played back.

- The file is copy protected.
- The file is recorded with a bit rate under 48 kbps. The RDV-1040 does not support such WMA files.

Glossary

Aspect ratio

A ratio which defines the shape of the rectangular picture in a TV. It is the width of the picture relative to the height. A conventional TV picture has 4:3 in aspect ratio.

Bitstream

The digital form of multichannel audio data (e.g., 5.1-channel) before it is decoded into its various channels.

Chapter/title

Chapter is the smallest division and title is the largest division on DVD Video. A chapter is a division of a title and similar to a track for Video CD or Audio CD.

Component video

Video signals with three separate channels of information that make up the picture. There are several types of component video, such as R/G/B and Y/CB(PB)/CR(PR).

Composite video

A single video signal commonly used in most consumer video products that contains all luminance, color, and synchronization information.

Dolby Digital (AC3)

A six-channel system consisting of left, center, right, left rear, right rear and LFE (Low-Frequency Effect channel for use with a sub-woofer) channels. All processing is done in the digital domain. Not all Dolby Digital discs contain six (5.1) channels of information.

Dolby Surround/Dolby Pro Logic

Dolby Surround records four channels of front and rear audio in two channels in a way that allows a decoder to recover the original four channels for playback. Because the audio is recorded in two channels, it can be played back by a two-channel stereo system.

Dolby Pro Logic introduces directional circuits in decoder-side processing (increasing the level of specific channels and lowering the level of silent channels) for greater spatial perspective, and adds a center speaker used primarily for dialog. The result is enhanced channel separation.

Down-mix

Internal stereo mix of multichannel surround audio by a DVD player. The down-mix signals are output from stereo output connectors.

DTS

DTS stands for Digital Theater Systems, a Digital Surround audio encoding format configured with six (5.1) channels, similar to Dolby Digital. It requires a decoder, either in the player or in an external receiver. Not all DTS discs contain six (5.1) channels of information.

Dynamic range

The difference between the loudest and softest sounds.

JPEG

A popular file format for still image compression and storage. JPEG stands for Joint Photographic Experts Group.

There are three sub-types of the JPEG format as follows.

- baseline JPEG: used for digital cameras, the web, etc.
- progressive JPEG: used for the web
- lossless JPEG: an old type, rarely used now

Linear PCM audio

PCM stands for "pulse code modulation." Linear PCM is the usual method for digitally encoding audio without compression, and is used for the audio tracks on DVD Video discs, Audio CDs, etc.

MP3

MP3 is an audio data compression format, which stands for MPEG-1 Audio Layer 3. Using MP3, you can achieve a data reduction of about 1:10.

MPEG

MPEG stands for Moving Picture coding Experts Group. MPEG is a family of standards for compressing audio-visual information. "MPEG" standards include MPEG-1, MPEG-2 and MPEG-4. Video CD and MP3 are based on MPEG-1, while DVD is based on MPEG-2.

MPEG Multichannel

This feature expands the 5.1 channel audio format recorded on the disc to a 7.1 channel format. The further expansion of the 5.1 channel audio makes it easy for you to reproduce the movie theater experience in your own home.

PAL (Phase Alternation by Line)

A color television system format used extensively in Western Europe.

PBC

PBC stands for "Playback control" and is a method of controlling disc play for Video CDs (VCD). You are able to interact with the disc through menus.

RGB

An abbreviation for Red, Green and Blue. Color monitors and color television sets display different hues by mixing these three colors.

S-video

A video signal which improves picture quality over standard composite connections. Used on Super VHS, DVD, high end TV monitors, etc.

Track

The smallest division on SVCD, Video CD and Audio CD discs.

WMA

WMA is an abbreviation of "Windows Media Audio," and is an audio data compression format developed by Microsoft Corporation. Sound quality of data compressed using WMA is the same as that of MP3, though the WMA file size is smaller than that of MP3.

Specifications

General

Readable Discs

DVD VIDEO, DVD-R (Video format), DVD RW (Video format), +RW (Video format), SVCD, Video CD, Audio CD (CD-DA), MP3/WMA format, JPEG, CD-R/RW (CD-DA), SVCD, Video CD, MP3/WMA format, JPEG)

Video Format

NTSC, 480i (Interlaced scan)/
480p (Progressive scan) selectable
PAL (576i only)

Other

Power Requirements

AC 120 V – 240 V, 50-60 Hz

Power Consumption

12 W (Power On), 0.7 W (Standby mode)

Weight

10 lbs. / 4.5 Kg

Dimension (W x H x D)

17 x 3^{11/16} x 13^{3/8} inches
432 x 93 x 340 mm

Video Outputs

Component (pin jacks)

Y Output

1.0 Vp-p (75 ohm)

PB/PR Output

0.7 Vp-p (75 ohm)

Video Out (pin jack)

1.0 Vp-p (75 ohm)

S-Video Out (S jack)

Y Output: 1.0 Vp-p (75 ohm)

C Output

286 mVp-p (75 ohm)

Horizontal Resolution

500 lines or more

Audio Outputs

Analog Out (pin jack)

2.0 Vrms (10 k ohm)

Digital Out (Coaxial)

0.5 Vp-p (75 ohm termination)

Digital Out (Optical)

-21 dBm to -15 dBm (peak)

Audio Characteristics

Frequency Response

CD (sampling frequency 44.1 kHz)

2 Hz to 20 kHz

DVD (sampling frequency 48 kHz)

2 Hz to 22 kHz
(4 Hz to 20 kHz for DTS and
Dolby Digital bitstream signals)

DVD (sampling frequency 96 kHz)

2 Hz to 44 kHz

Dynamic Range

16 bit

More than 98 dB

20/24 bit

More than 100 dB

Wow and Flutter

Unmeasurable (less than + 0.002%)

Total Harmonic Distortion

Less than 0.006%

Specifications and appearance subject to change without prior notice.

DTS is a registered trademark of Digital Theater Systems. Manufactured under license from Dolby Laboratories Licensing Corporation. "Dolby" and the double-D symbol are trademarks of Dolby Laboratories Licensing Corporation. All rights reserved.

Appendix A: Country Code List for Parental Lock

AD	Andorra	EH	Western Sahara	LB	Lebanon	RW	Rwanda
AE	United Arab Emirates	ES	Spain	LC	Saint Lucia	SA	Saudi Arabia
AF	Afghanistan	ET	Ethiopia	LI	Liechtenstein	SB	Solomon Islands
AG	Antigua and Barbuda	FI	Finland	LK	Sri Lanka	SC	Seychelles
AI	Anguilla	FJ	Fiji	LR	Liberia	SD	Sudan
AL	Albania	FK	Falkland Islands (Malvinas)	LS	Lesotho	SE	Sweden
AM	Armenia	FM	Micronesia (Federated States of)	LT	Lithuania	SG	Singapore
AN	Netherlands Antilles	FO	Faroe Islands	LU	Luxembourg	SH	Saint Helena
AO	Angola	FR	France	LV	Latvia	SI	Slovenia
AQ	Antarctica	FX	France, Metropolitan	LY	Libyan Arab Jamahiriya	SJ	Svalbard and Jan Mayen
AR	Argentina	GA	Gabon	MA	Morocco	SK	Slovakia
AS	American Samoa	GB	United Kingdom	MC	Monaco	SL	Sierra Leone
AT	Austria	GD	Grenada	MD	Moldova, Republic of	SM	San Marino
AU	Australia	GE	Georgia	MG	Madagascar	SN	Senegal
AW	Aruba	GF	French Guiana	MH	Marshall Islands	SO	Somalia
AZ	Azerbaijan	GH	Ghana	ML	Mali	SR	Suriname
BA	Bosnia and Herzegovina	GI	Gibraltar	MM	Myanmar	ST	Sao Tome and Principe
BB	Barbados	GL	Greenland	MN	Mongolia	SV	El Salvador
BD	Bangladesh	GM	Gambia	MO	Macau	SY	Syrian Arab Republic
BE	Belgium	GN	Guinea	MP	Northern Mariana Islands	SZ	Swaziland
BF	Burkina Faso	GP	Guadeloupe	MQ	Martinique	TC	Turks and Caicos Islands
BG	Bulgaria	GQ	Equatorial Guinea	MR	Mauritania	TD	Chad
BH	Bahrain	GR	Greece	MS	Montserrat	TF	French Southern Territories
BI	Burundi	GS	South Georgia and the South Sandwich Islands	MT	Malta	TG	Togo
BJ	Benin	GT	Guatemala	MU	Mauritius	TH	Thailand
BM	Bermuda	GU	Guam	MV	Maldives	TJ	Tajikistan
BN	Brunei Darussalam	GW	Guinea-Bissau	MW	Malawi	TK	Tokelau
BO	Bolivia	GY	Guyana	MX	Mexico	TM	Turkmenistan
BR	Brazil	HK	Hong Kong	MY	Malaysia	TN	Tunisia
BS	Bahamas	HM	Heard Island and McDonald Islands	MZ	Mozambique	TO	Tonga
BT	Bhutan	HN	Honduras	NA	Namibia	TP	East Timor
BV	Bouvet Island	HR	Croatia	NC	New Caledonia	TR	Turkey
BW	Botswana	HT	Haiti	NE	Niger	TT	Trinidad and Tobago
BY	Belarus	HU	Hungary	NF	Norfolk Island	TV	Tuvalu
BZ	Belize	ID	Indonesia	NG	Nigeria	TW	Taiwan
CA	Canada	IE	Ireland	NI	Nicaragua	TZ	Tanzania, United Republic of
CC	Cocos (Keeling) Islands	IL	Israel	NL	Netherlands	UA	Ukraine
CF	Central African Republic	IN	India	NO	Norway	UG	Uganda
CG	Congo	IO	British Indian Ocean Territory	NP	Nepal	UM	United States Minor Outlying Islands
CH	Switzerland	IQ	Iraq	NR	Nauru	US	United States
CI	Côte d'Ivoire	IR	Iran (Islamic Republic of)	NU	Niue	UY	Uruguay
CK	Cook Islands	IS	Iceland	NZ	New Zealand	UZ	Uzbekistan
CL	Chile	IT	Italy	OM	Oman	VA	Vatican City State (Holy See)
CM	Cameroon	JM	Jamaica	PA	Panama	VC	Saint Vincent and the Grenadines
CN	China	JO	Jordan	PE	Peru	VE	Venezuela
CO	Colombia	JP	Japan	PF	French Polynesia	VG	Virgin Islands (British)
CR	Costa Rica	KE	Kenya	PG	Papua New Guinea	VI	Virgin Islands (U.S.)
CU	Cuba	KG	Kyrgyzstan	PH	Philippines	VN	Vietnam
CV	Cape Verde	KH	Cambodia	PK	Pakistan	VU	Vanuatu
CX	Christmas Island	KI	Kiribati	PL	Poland	WF	Wallis and Futuna Islands
CY	Cyprus	KM	Comoros	PM	Saint Pierre and Miquelon	WS	Samoa
CZ	Czech Republic	KN	Saint Kitts and Nevis	PN	Pitcairn	YE	Yemen
DE	Germany	KP	Korea, Democratic People's Republic of	PR	Puerto Rico	YT	Mayotte
DJ	Djibouti	KR	Korea, Republic of	PW	Palau	YU	Yugoslavia
DK	Denmark	KW	Kuwait	PY	Paraguay	ZA	South Africa
DM	Dominica	KY	Cayman Islands	QA	Qatar	ZM	Zambia
DO	Dominican Republic	KZ	Kazakhstan	RE	Réunion	ZR	Zaire
DZ	Algeria	LA	Lao People's Democratic Republic	RO	Romania	ZW	Zimbabwe
EC	Ecuador			RU	Russian Federation		
EE	Estonia						
EG	Egypt						

Appendix B: Table of Languages and Their Abbreviations

When you select the menu, audio or subtitle language it is sometimes necessary to enter a two-letter language code. Enter one of the codes below to select the corresponding language.

AA Afar	GL Galician	MK Macedonian	SM Samoan
AB Abkhazian	GN Guarani	ML Malayalam	SN Shona
AF Afrikaans	GU Gujarati	MN Mongolian	SO Somali
AM Ameharic	HA Hausa	MO Moldavian	SQ Albanian
AR Arabic	HI Hindi	MR Marathi	SR Serbian
AS Assamese	HR Croatian	MS Malay (MAY)	SS Siswati
AY Aymara	HU Hungarian	MT Maltese	ST Sesotho
AZ Azerbaijani	HY Armenian	MY Burmese	SU Sundanese
BA Bashkir	IA Interlingua	NA Nauru	SV Swedish
BE Byelorussian	IE Interlingue	NE Nepali	SW Swahili
BG Bulgarian	IK Inupiak	NL Dutch	TA Tamil
BH Bihari	IN Indonesian	NO Norwegian	TE Telugu
BI Bislama	IS Icelandic	OC Occitan	TG Tajik
BN Bengali, Bangla	IW Hebrew	OM (Afan) Oromo	TH Thai
BO Tibetan	JI Yiddish	OR Oriya	TI Tigrinya
BR Breton	JW Javanese	PA Panjabi	TK Turkmen
CA Catalan	KA Georgian	PL Polish	TL Tagalog
CO Corsican	KK Kazakh	PS Pashto, Pushto	TN Setswana
CS Czech	KL Greenlandic	PT Portuguese	TO Tongan
CY Welsh	KM Cambodian	QU Quechua	TR Turkish
DA Danish	KN Kannada	RM Rhaeto-Romance	TS Tsonga
DZ Bhutani	KO Korean (KOR)	RN Kirundi	TT Tatar
EL Greek	KS Kashmiri	RO Rumanian	TW Twi
EO Esperanto	KU Kurdish	RU Russian	UK Ukrainian
ET Estonian	KY Kirghiz	RW Kinyarwanda	UR Urdu
EU Basque	LA Latin	SA Sanskrit	UZ Uzbek
FA Persian	LN Lingala	SD Sindhi	VI Vietnamese
FI Finnish	LO Laothian	SG Sangho	VO Volapuk
FJ Fiji	LT Lithuanian	SH Serbo-Croatian	WO Wolof
FO Faroese	LV Latvian, Lettish	SI Singhalese	XH Xhosa
FY Frisian	MG Malagasy	SK Slovak	YO Yoruba
GA Irish	MI Maori	SL Slovenian	ZU Zulu
GD Scots Gaelic			

Appendix C: Digital Signal Output Chart

Disc type	Output		
	PCM ONLY	DOLBY DIGITAL/PCM	STREAM/PCM
DVD with 48/44.1 kHz, 16/20/24 bit linear PCM	48/44.1 kHz, 16 bit, stereo linear PCM		
DVD with 96 kHz, 16/22/24 bit linear PCM	48kHz, 16 bit, stereo linear PCM (Down sampling)		
DVD with DTS	48kHz, 16 bit, stereo linear PCM	DTS bitstream	
DVD with Dolby Digital	48 kHz, 16 bit, stereo linear PCM	Dolby Digital bitstream	
DVD with MPEG Multichannel	48 kHz, 16 bit, stereo linear PCM	MPEG bitstream	
SVCD/Video CD/Audio CD	44.1 kHz, 16 bit, stereo linear PCM		
Audio CD with DTS	48kHz, 16 bit, stereo linear PCM	DTS bitstream	
CD-R/RW with MP3/WMA	Linear PCM		

COVER GRAPHIC PLACEHOLDER

ROTEL®

The Rotel Co. Ltd.
10-10 Shinsen-Cho
Shibuya-Ku
Tokyo 150-0045
Japan
Phone: +81 3-5458-5325
Fax: +81 3-5458-5310

Rotel of America
54 Concord Street
North Reading, MA 01864-2699
USA
Phone: +1 978-664-3820
Fax: +1 978-664-4109

Rotel Europe
Dale Road
Worthing, West Sussex BN11 2BH
England
Phone: +44 (0)1903 221 600
Fax: +44 (0)1903 221 525

Rotel Deutschland
Kleine Heide 12
D-33790 Halle/Westf.
Germany
Phone: +49 05201-87170
Fax: +49 05201-73370

www.rotel.com

Composite Input TV Connection

Connect the COMPOSITE VIDEO 16 output to the composite video input of your TV. Connect the ANALOG AUDIO 12 outputs to the audio inputs of your TV. A cable for these connections is supplied.

If your TV has a single monaural audio input instead of a pair of stereo inputs, you need to use a "Y" cable adapter to connect the two output channels of the RDV-1040 to the single input.

You can improve the sound quality of the system by connecting the audio outputs to a separate hi-fi audio system. (See the following section.)

S-Video Input TV Connection

If your TV has an S-video input, you should connect it to the S-VIDEO 15 output of RDV-1040 using an S-video cable. This will produce better picture quality.

NOTE: When the S-Video output is connected the Component Video outputs do not work.

Component Input TV Connection

If your TV has component video signal input jacks you will get better video performance by using the COMPONENT VIDEO 17 output jacks of the RDV-1040. The required cable is not provided. Be sure to connect the "Y" output to the "Y" input, "Pb" output to the "Pb" input, and the "Pr" output to the "Pr" input.

NOTES: When using the Component Video outputs do not connect an S-Video cable.

The component signal inputs on some TV's have BNC type connectors. (BNC connectors are coaxial connectors that have keyed locking collars.) In such instances adapters or a special cable may be needed.

When the Component Video outputs are connected to an NTSC television you may be able to use the Progressive Scan mode of the RDV-1040 which produces a picture with less flicker. See the Remote/480p/480i Output Signal Selector Switch section. Not applicable to PAL televisions.

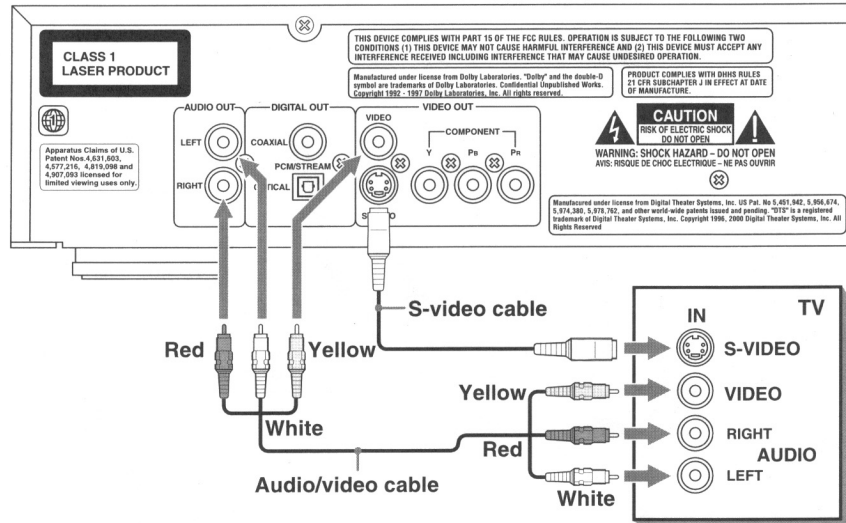

Correct Instruction of S-Video Input TV Connection

